

B

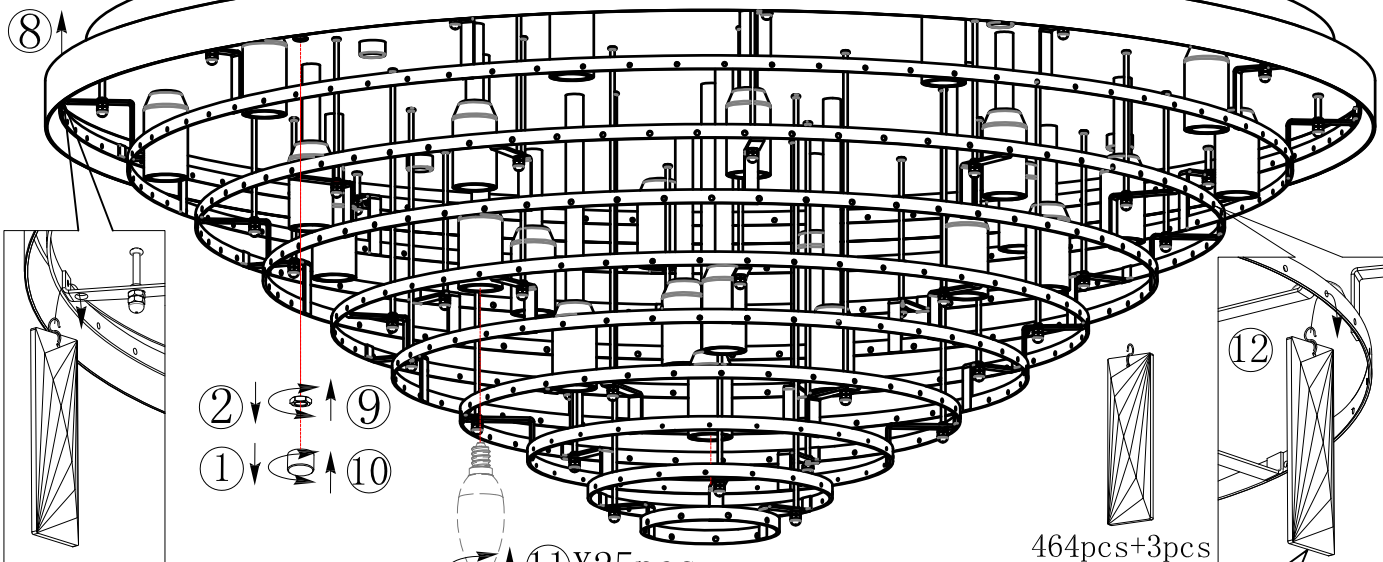

464pcs+3pcs

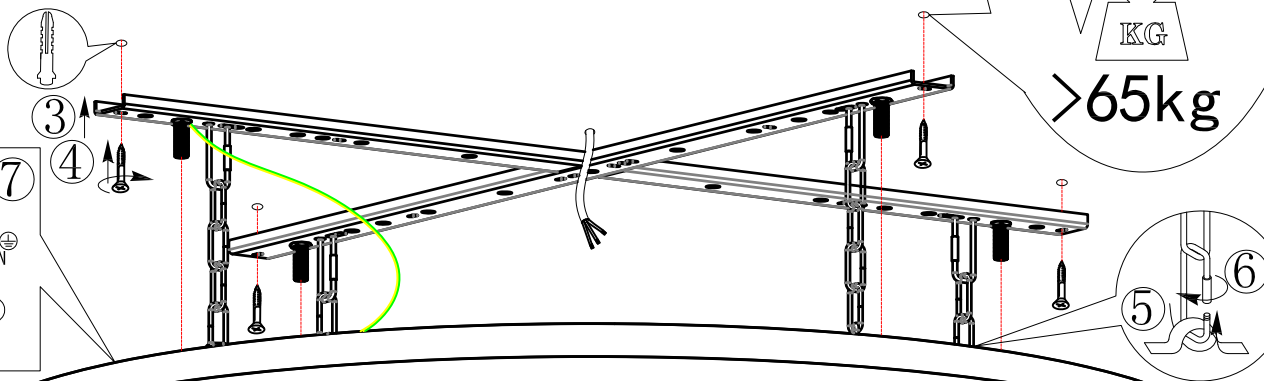
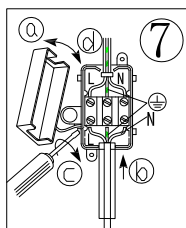
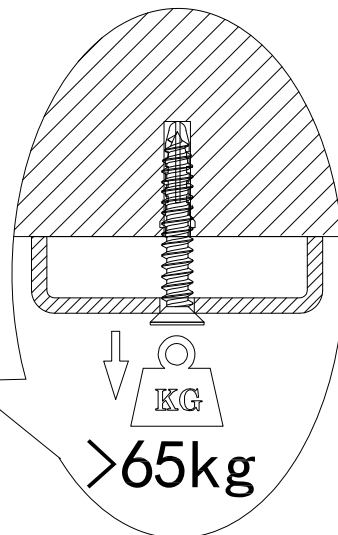
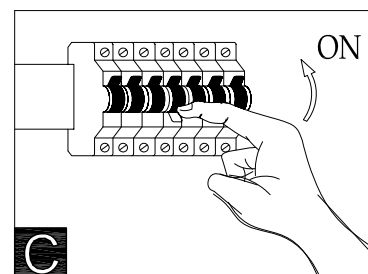
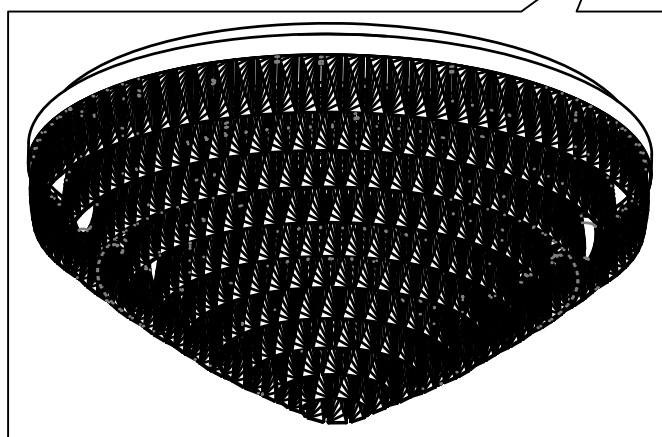
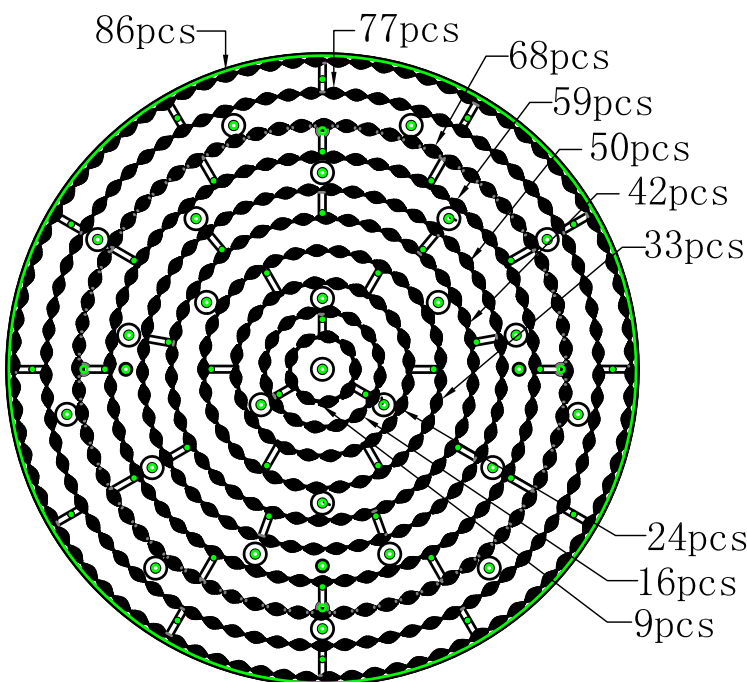
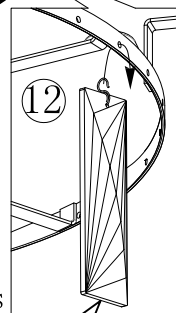

C