

OFF

B

A

>21kg

12

13

C

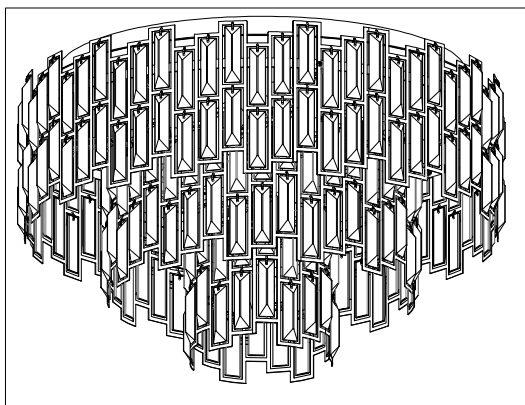
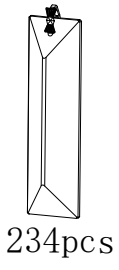
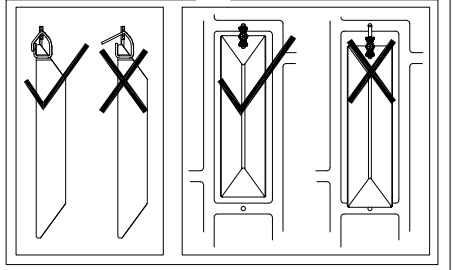
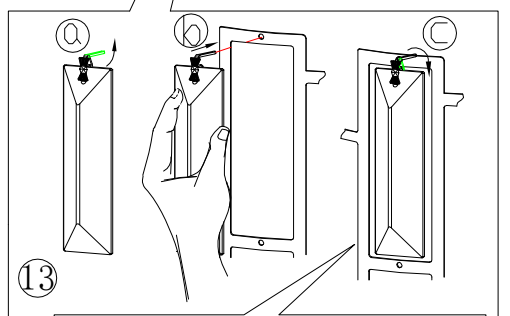
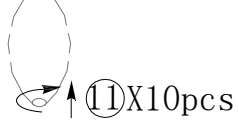
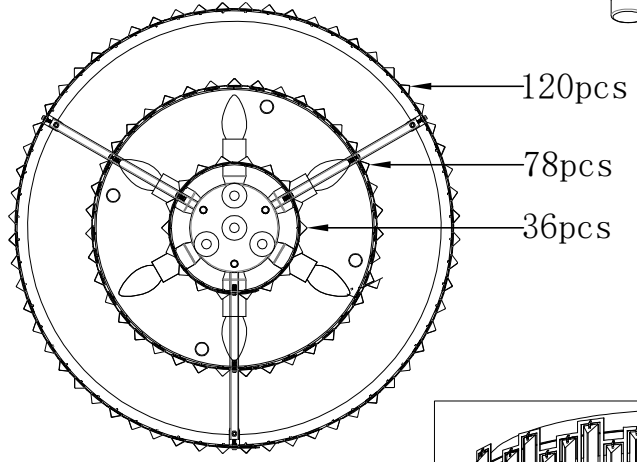
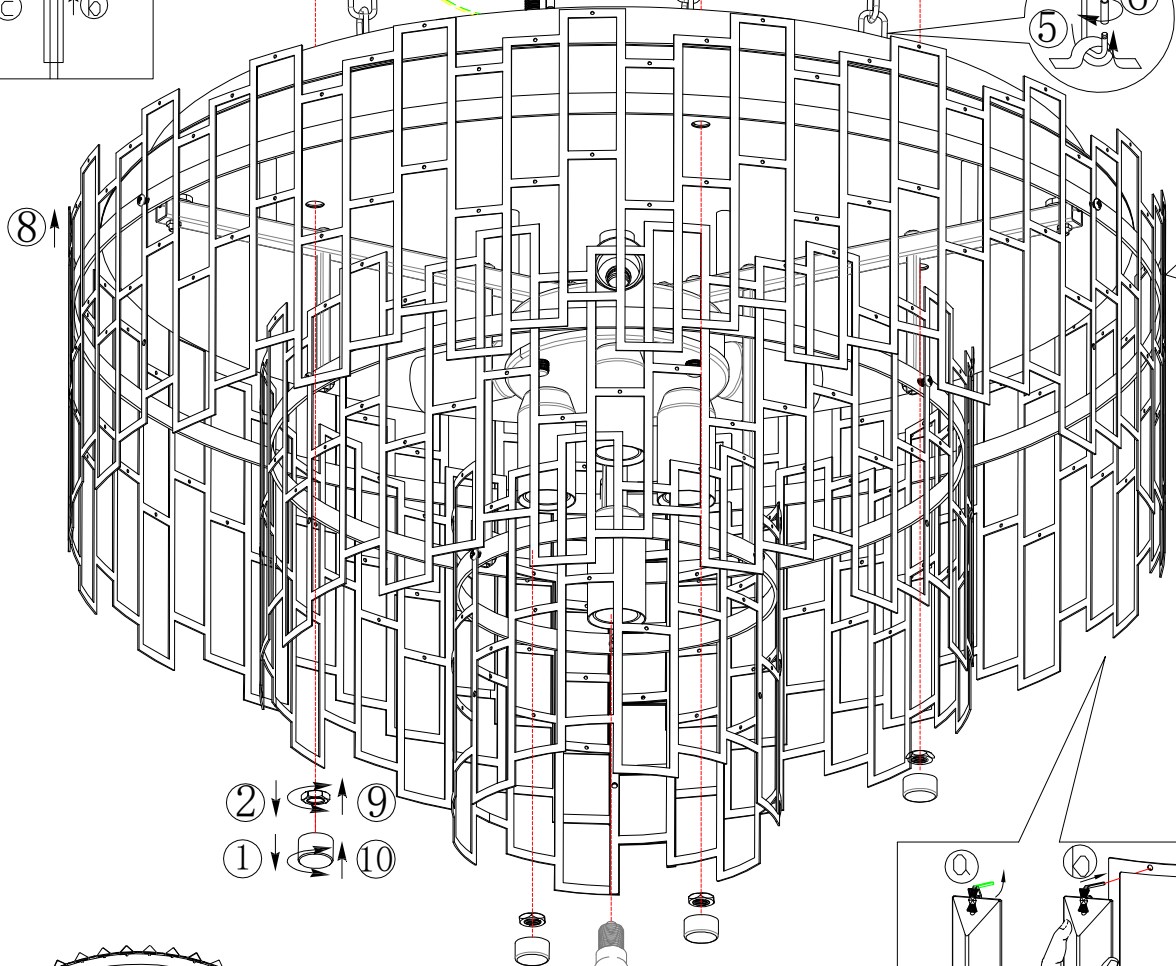
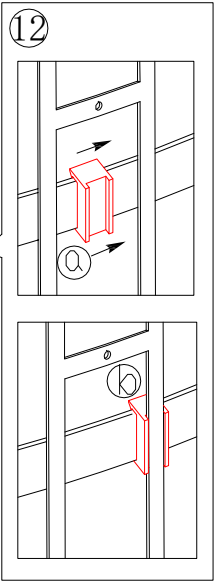
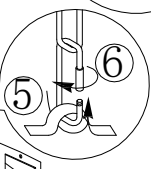
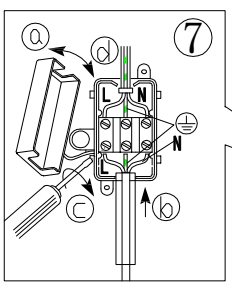
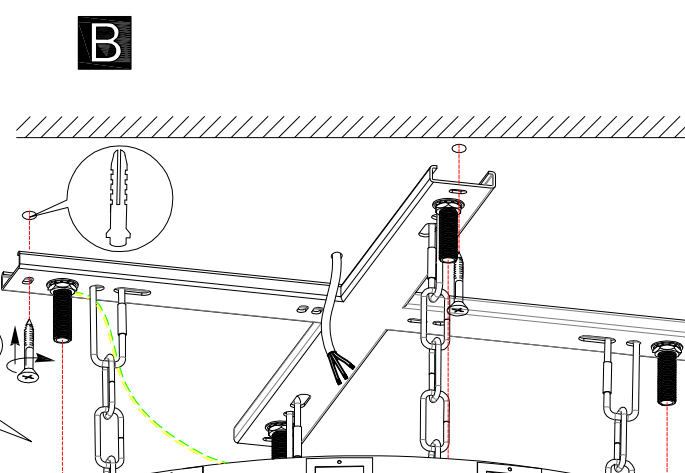
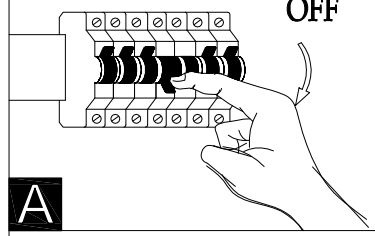

www.eglo.com

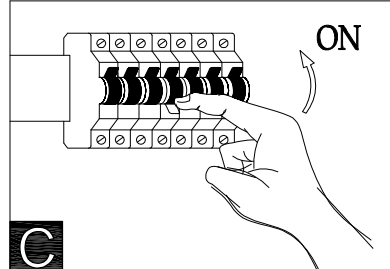

BLA39624