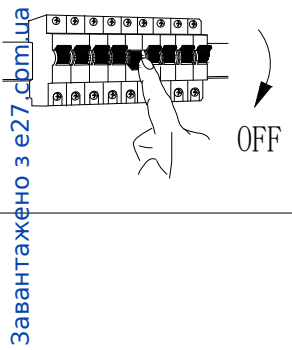
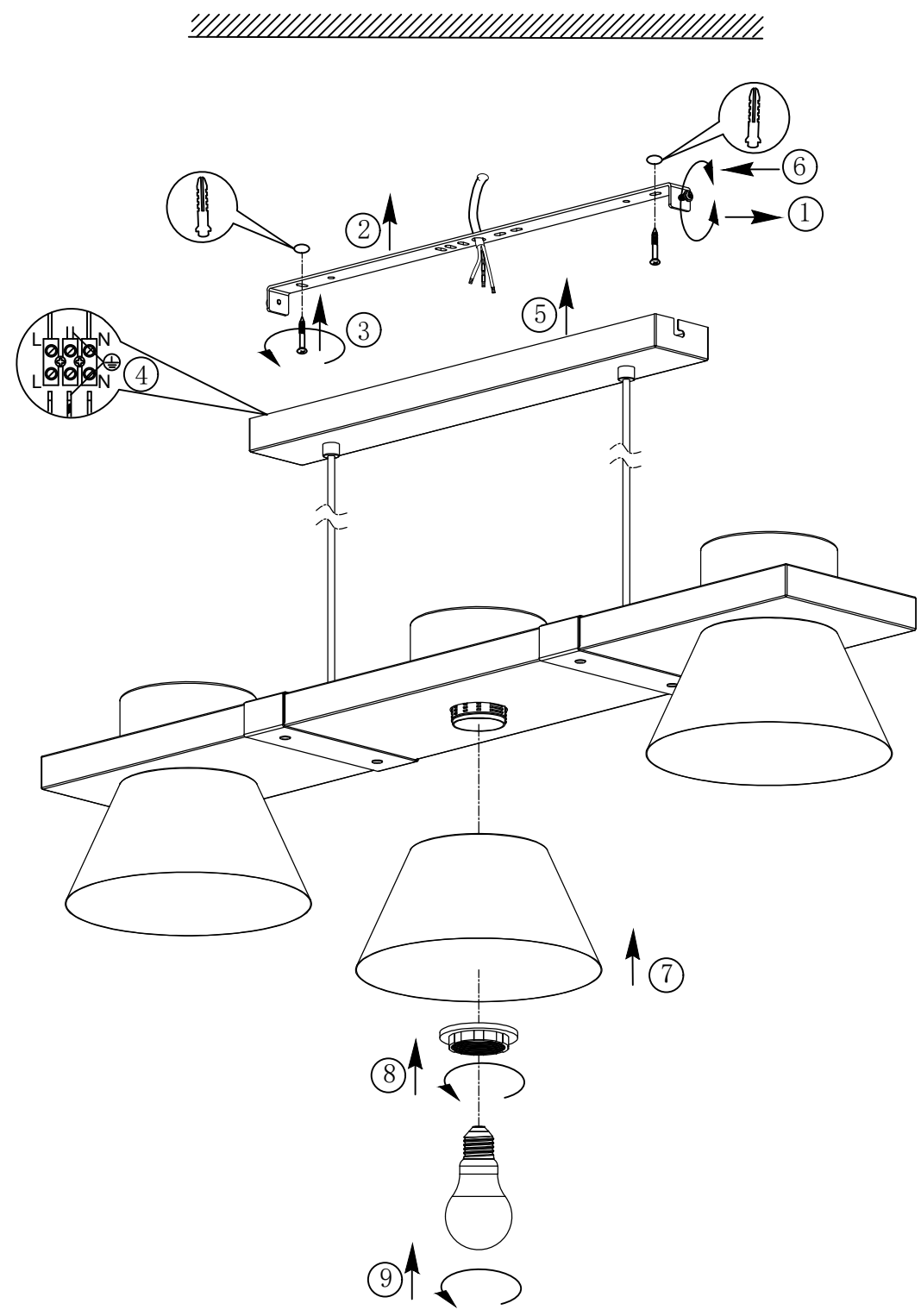
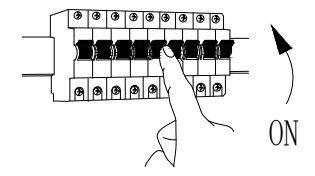

A**B****C**

B43956
www.eglo.com