

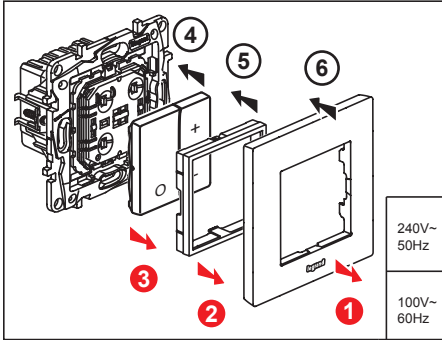

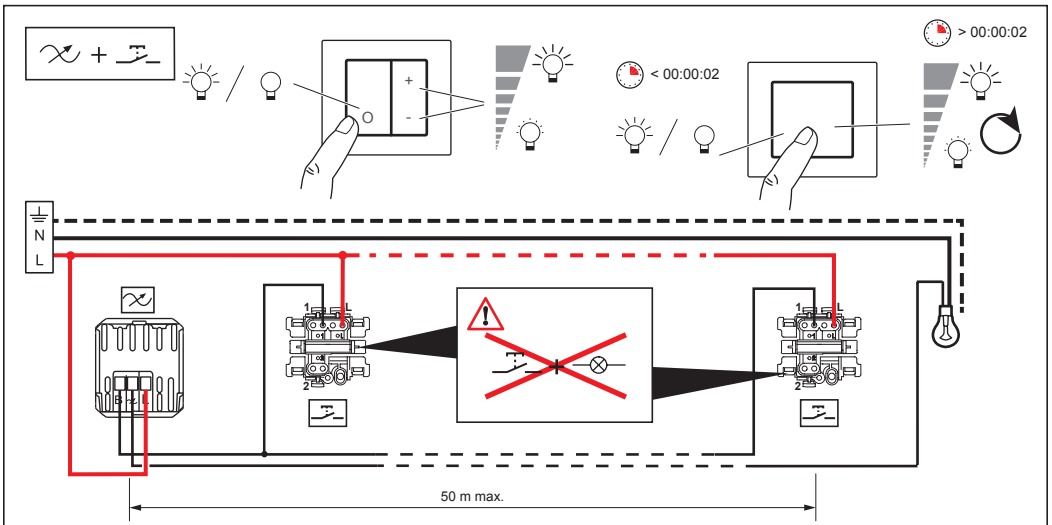

			U / f	
-10°C ... +70°C	-5°C ... +40°C	40 mm	100 ... 240 V~ 50 / 60 Hz	8 mm 1...2,5 mm <sup>2</sup>

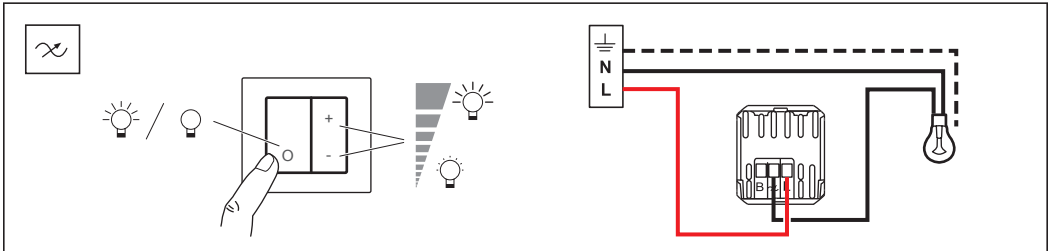

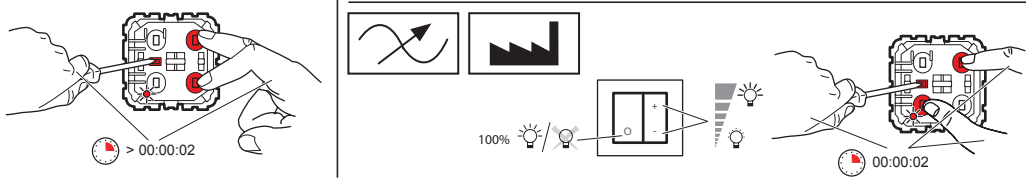
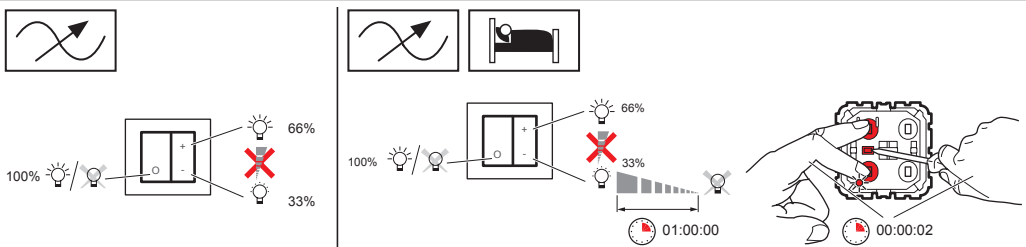
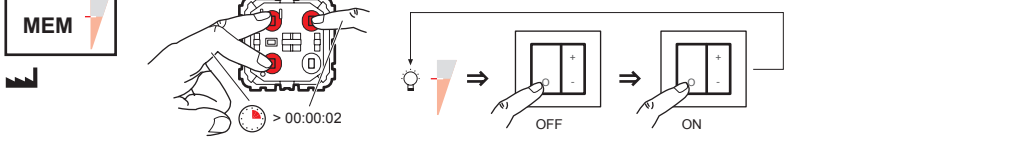
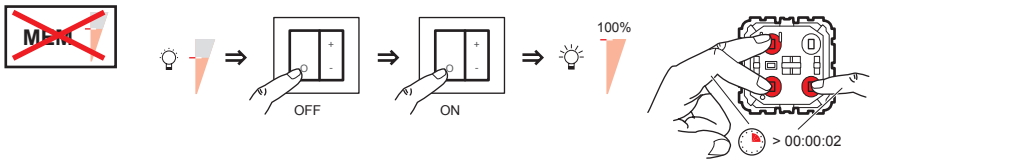
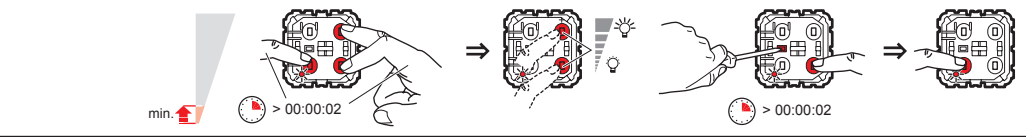
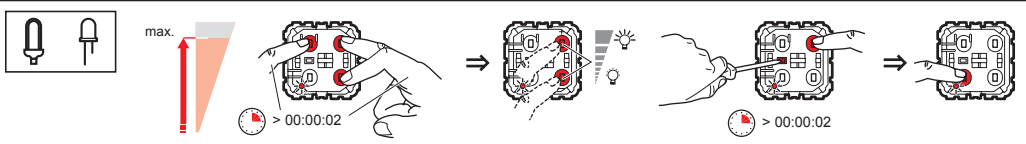
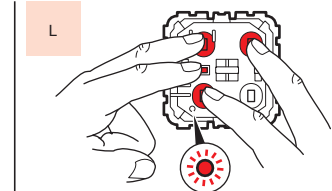
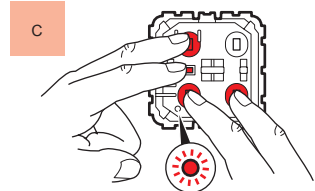
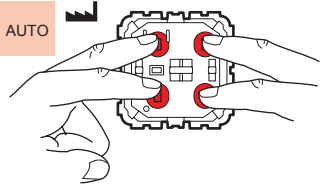
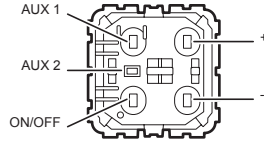
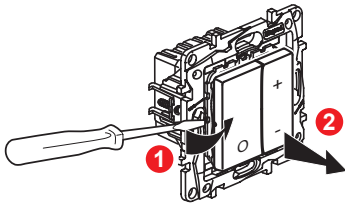

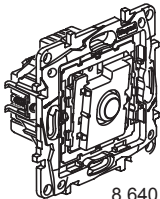

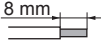

	R	L	CIL		Dimmable	Dimmable LED
240V~ 50Hz	3 ... 400 W	3 ... 400 VA	3 ... 200 VA	3 ... 400 VA	3 ... 200 VA	3 ... 75 W ≤ 10 x
100V~ 60Hz	3 ... 200 W	3 ... 200 VA	3 ... 100 VA	3 ... 200 VA	3 ... 100 VA	3 ... 37 W ≤ 10 x



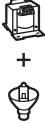

 <p>8 640 09</p>				U / f	
	-10°C ... +70°C	-5°C ... +40°C	40 mm	240 V~ 50 / 60 Hz	 <p>8 mm 1,5 mm<sup>2</sup></p>

 <p>00:10</p>	R		L	C/L				
								
230 V	Max.	150 W	150 W	150 VA	150 VA	100VA	650 mA	650 mA
	Min.	12 W	12 W	12 VA	12 VA	12 VA	50 mA	50 mA

