

VIRGO

7008201001



User manual
Bedienungsanleitung
Mode d'emploi
Handleiding
Manuale
Manual del usuario
Használati utasítás
Instrukcja obsługi



LUTEC

Incl.

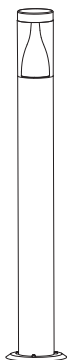

x 3



x 3

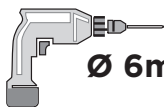

Ø 6mm



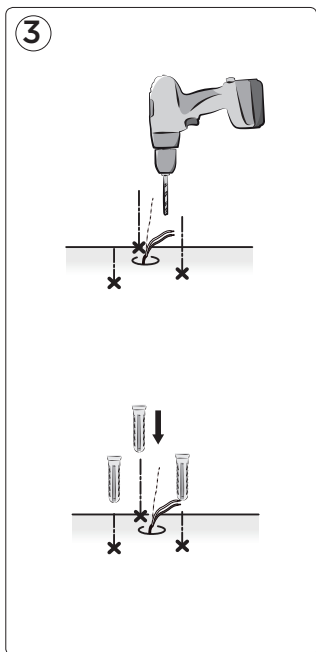
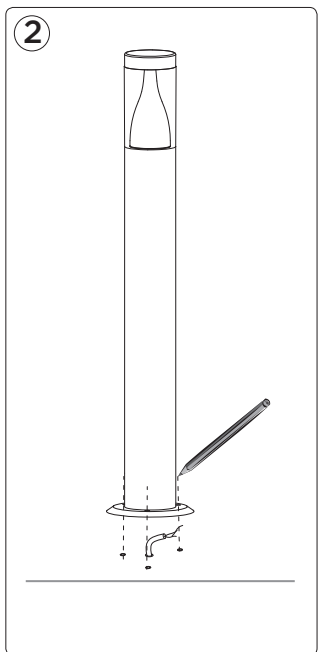
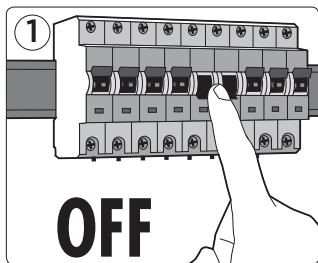

4



5

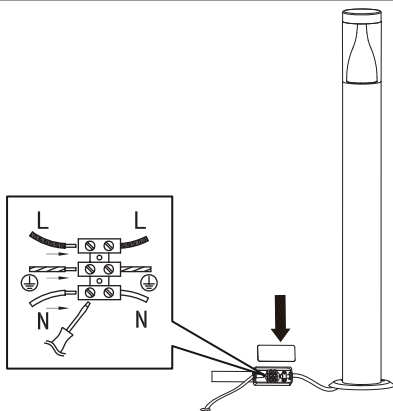

6

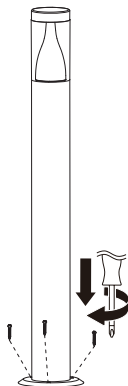



LUTEC Europe NV

Herentalsebaan 425
B-2160 Wommelgem - Belgium
+32 3 284 51 62
info@luteceurope.com
www.luteceurope.com



www.luteceurope.com/services/global-network