

# Art.: 245

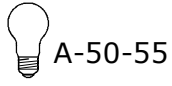

A-50-55



A-40-45

480

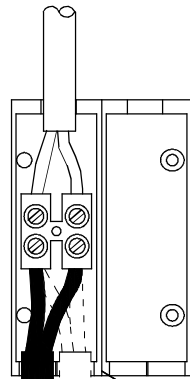
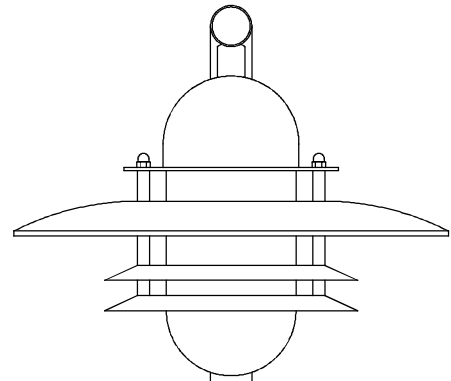
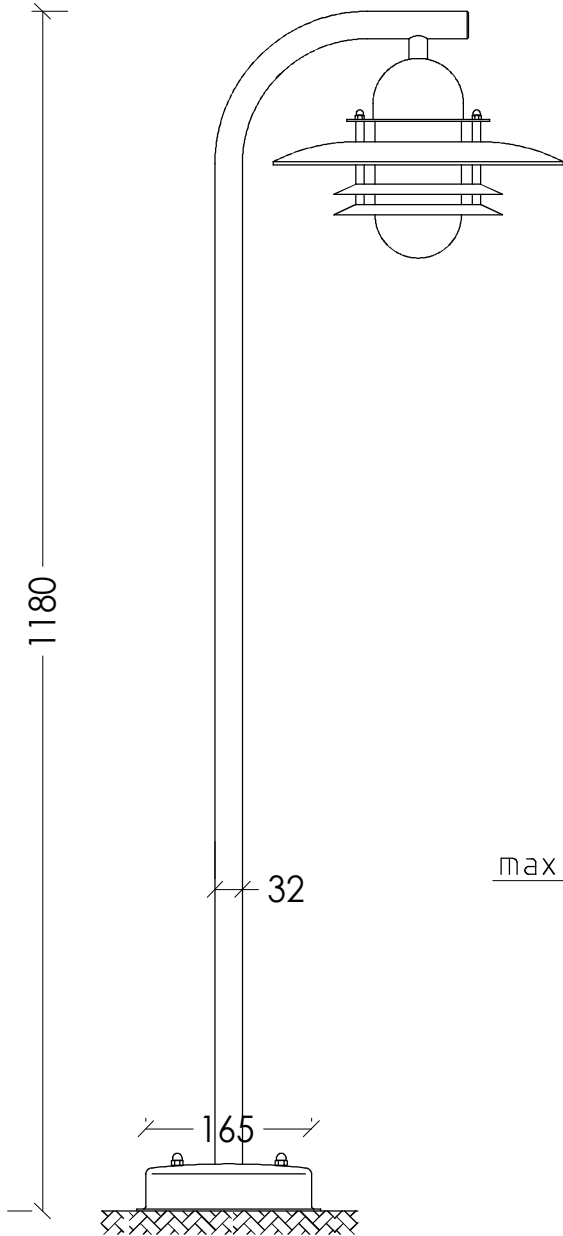

max  $\varnothing$ 12mm

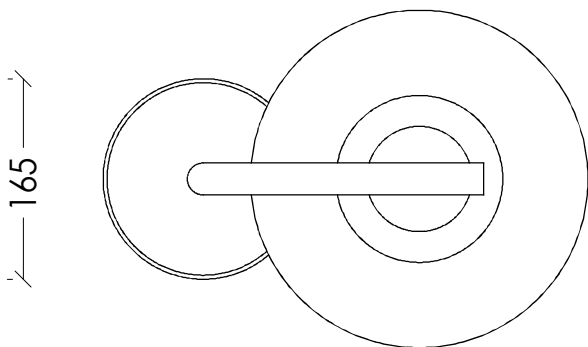
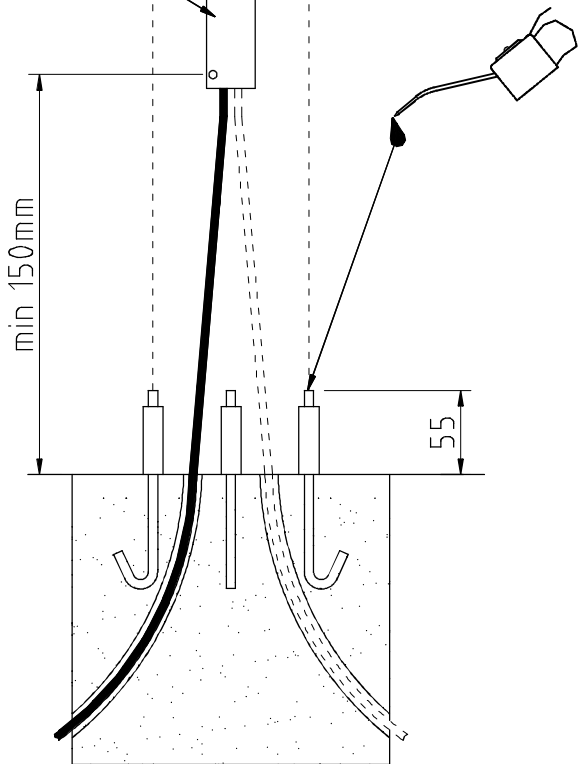

Front Art.245  
Footway  
FACE AVANT

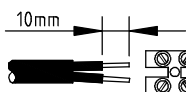
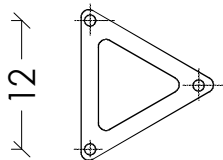

MAX 2,5 