

E 27 CLASS II 

Art.:2591

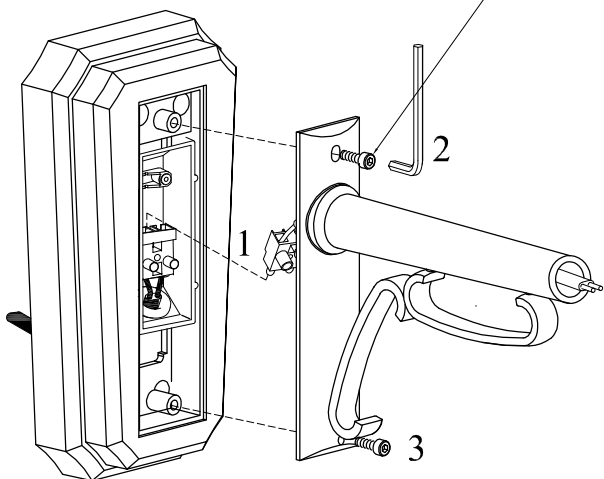

INSTR. N° 2591
IX-2011

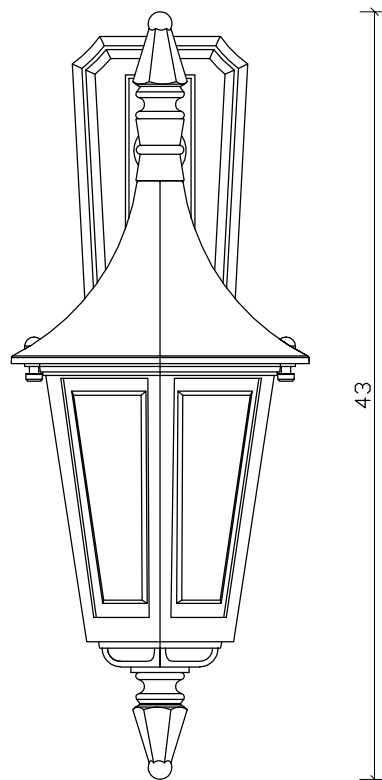
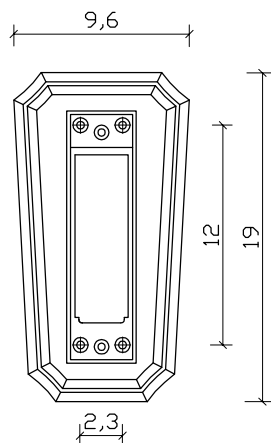
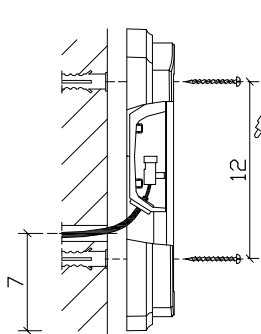
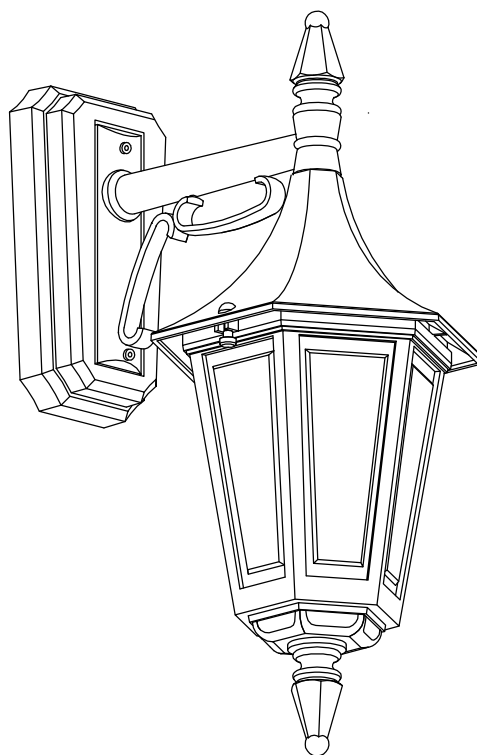
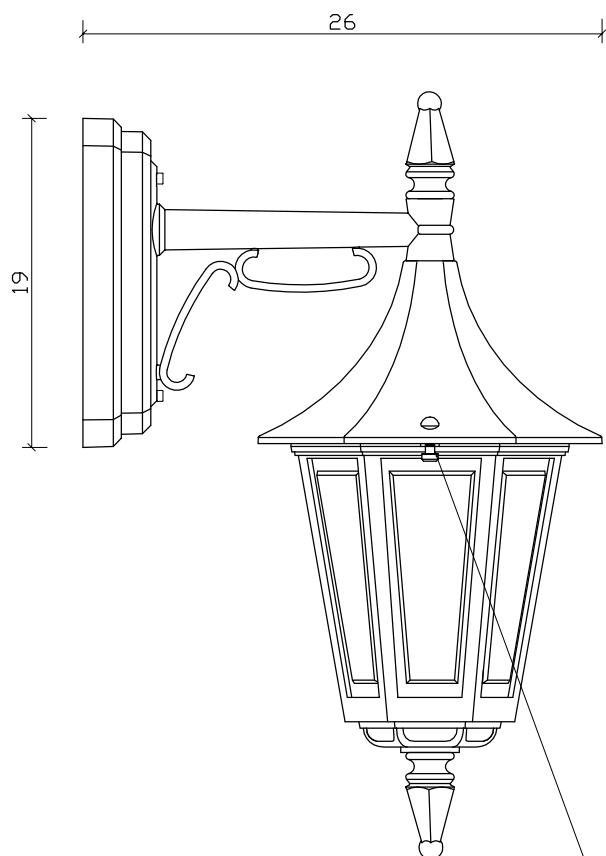
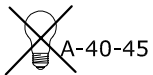
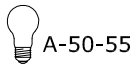