

CL OFFICE PRO LED 120, 31W

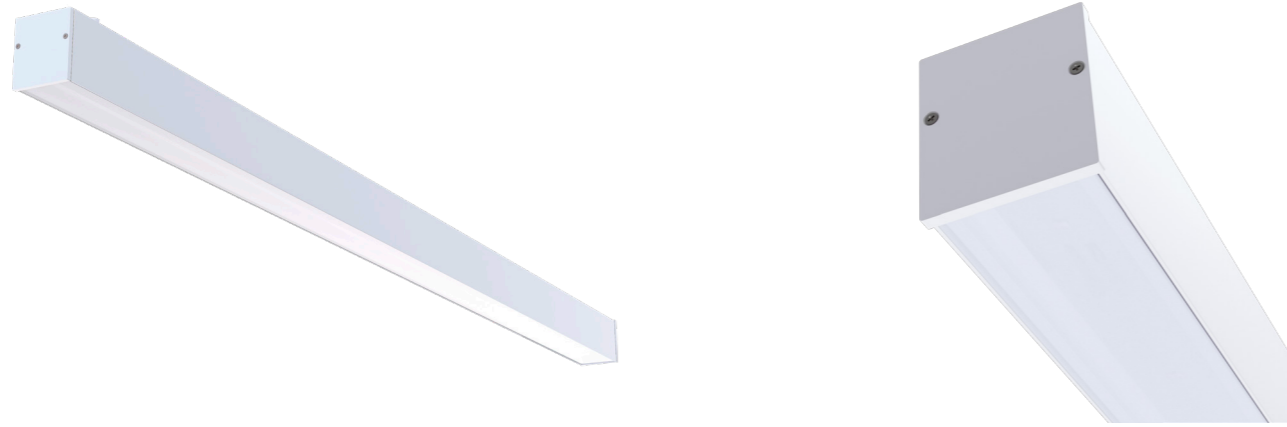

CL OFFICE PRO LED 120

aluminium / aluminum / алюминий

- 8298 ○ WH - 3000K 8300 ● BL - 3000K
- 8296 ○ WH - 4000K 8297 ● BL - 4000K

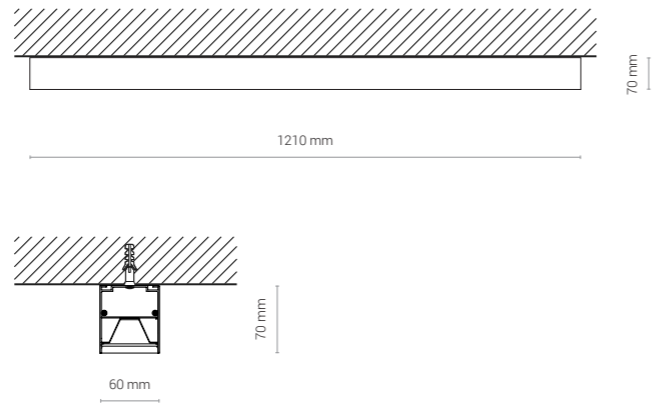

CL OFFICE PRO / HALL PRO SUSPENSION KIT

stal / steel / сталь

- 8291 ○ WH
- 8250 ● BL

CL OFFICE PRO / HALL PRO POWER SUPPLY KIT

przewód, stal lakierowana / wire, painted steel / проволока, лакированная сталь

- 8290 ○ WH
- 8288 ● BL

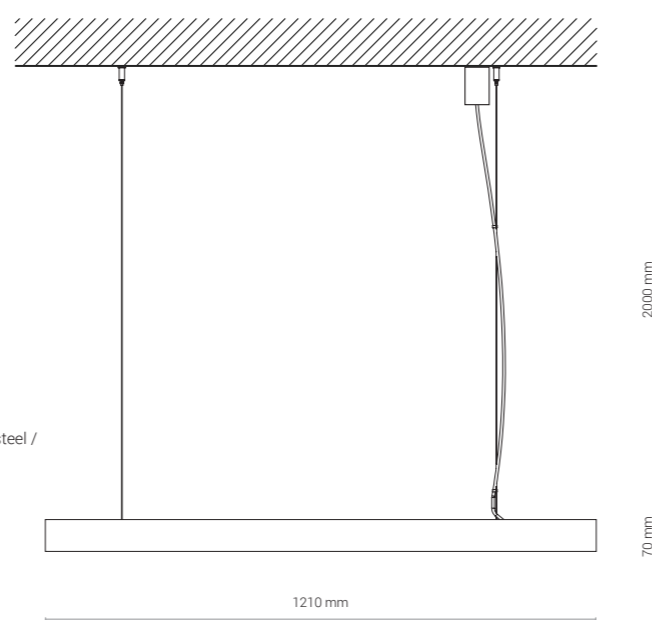

Item No.	POWER	COLOUR TEMP.	LUMEN	BEAM ANGLE	CRI	IP	LED BRAND	DRIVER BRAND	LIFETIME	WARRANTY
8298	31W	3000K	3760	90°	≥80	52	PHILIPS	PHILIPS	50000h	5 YEARS
8296	31W	4000K	4160	90°	≥80	52	PHILIPS	PHILIPS	50000h	5 YEARS
8300	31W	3000K	3490	90°	≥80	52	PHILIPS	PHILIPS	50000h	5 YEARS
8297	31W	4000K	3610	90°	≥80	52	PHILIPS	PHILIPS	50000h	5 YEARS

LUMINOUS INTENSITY DISTRIBUTION DIAGRAM

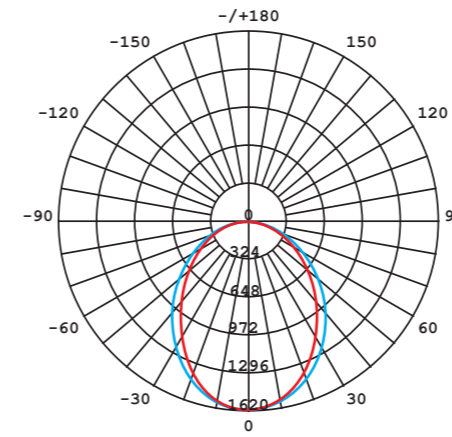

Luminous intensity [cd]
C0-C180 —
C90-C270 —

Beam cone diagram
Beam angle 90°

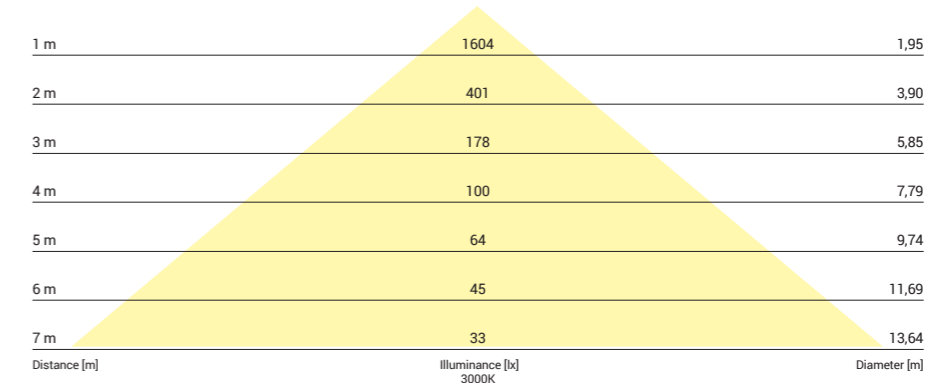

8298, 31W, 3000K, beam angle 90°

LUMINOUS INTENSITY DISTRIBUTION DIAGRAM

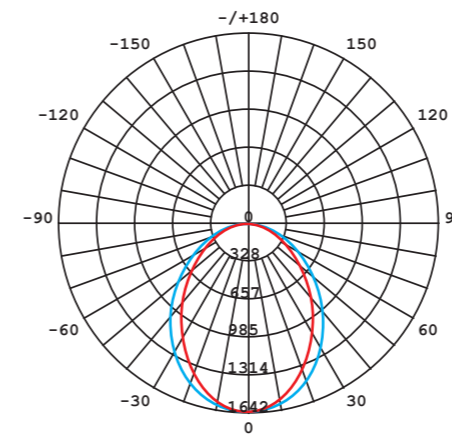

Luminous intensity [cd]
C0-C180 —
C90-C270 —

Beam cone diagram
Beam angle 90°

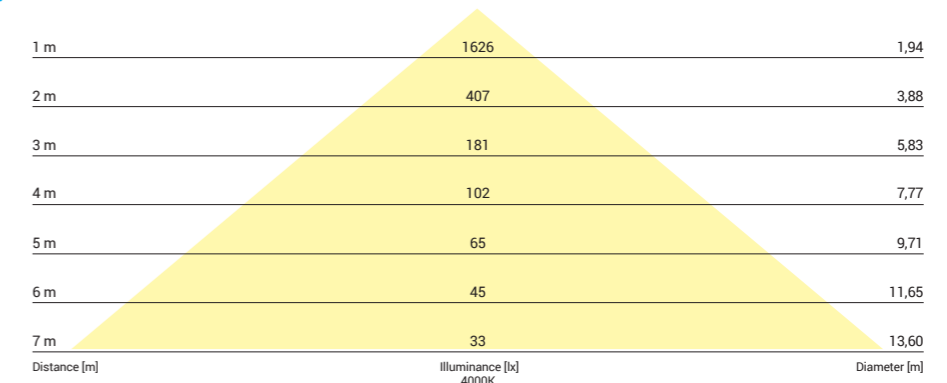

8297, 31W, 4000K, beam angle 90°