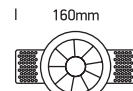

INSTALLATION MANUAL

10112XTR

LED
BUILT IN

**DARK
LIGHT**
**90
CRI**
CE EAC UK CA
**RoHS
COMPLIANT**

160mm



100mm

37mm

one
LIGHT

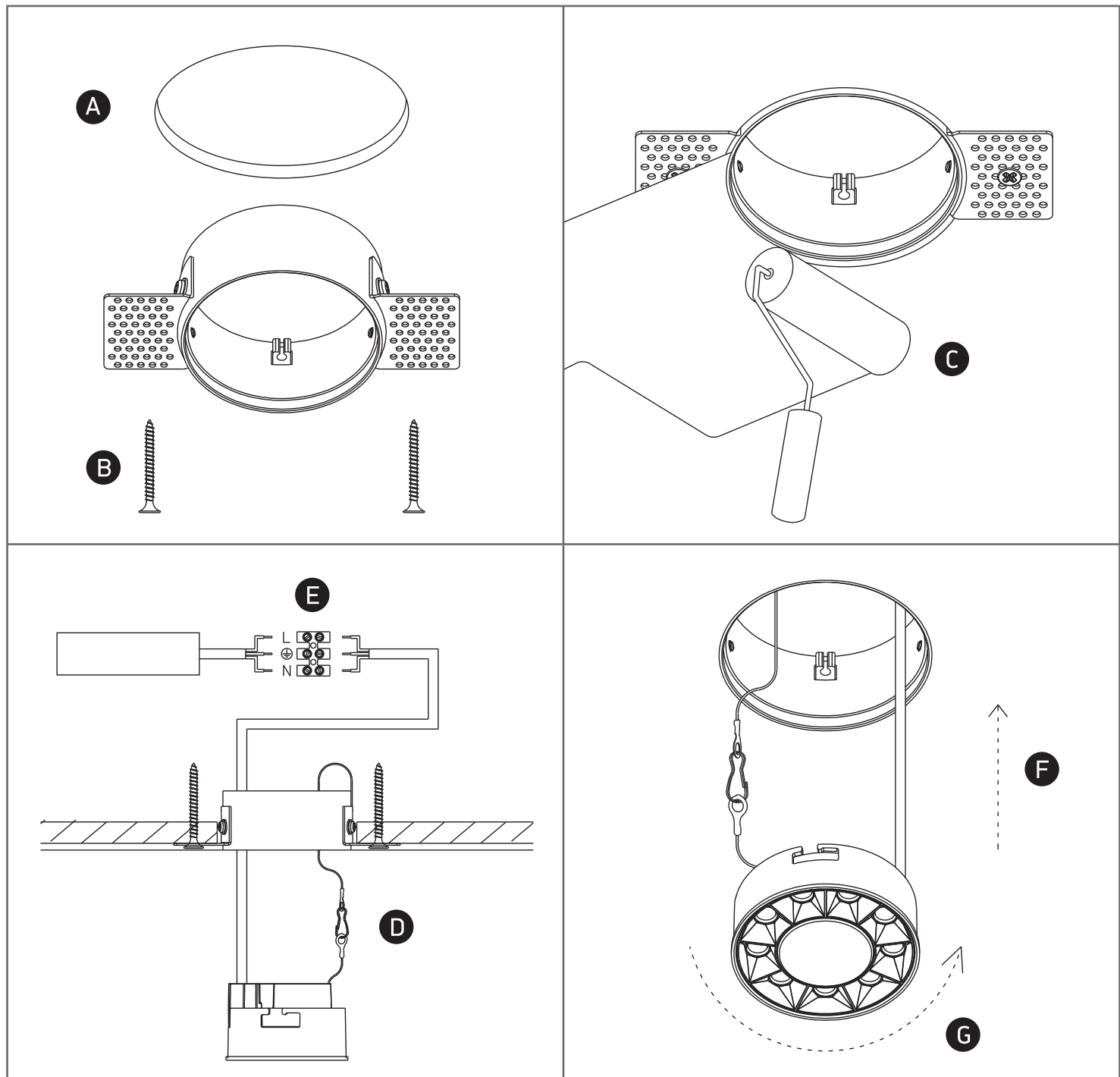
 230V | SMD 3030 | 12W | IP20 | Trimless | Aluminium
Complete with 300mA driver.

Warnings:

1. Make sure that the product is installed properly before connecting to electricity.
2. Do not cover the fitting.
3. Maintenance and installation should only be carried out by a professional electrician.