

INSTALLATION MANUAL

10125TD

ecodownlight

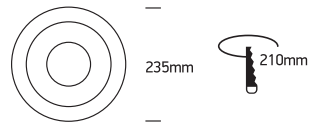

230V | SMD 2835 | 25W | IP54 | Aluminium

Complete with 600mA driver.

80
CRI

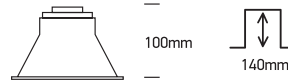
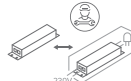

one
LIGHT

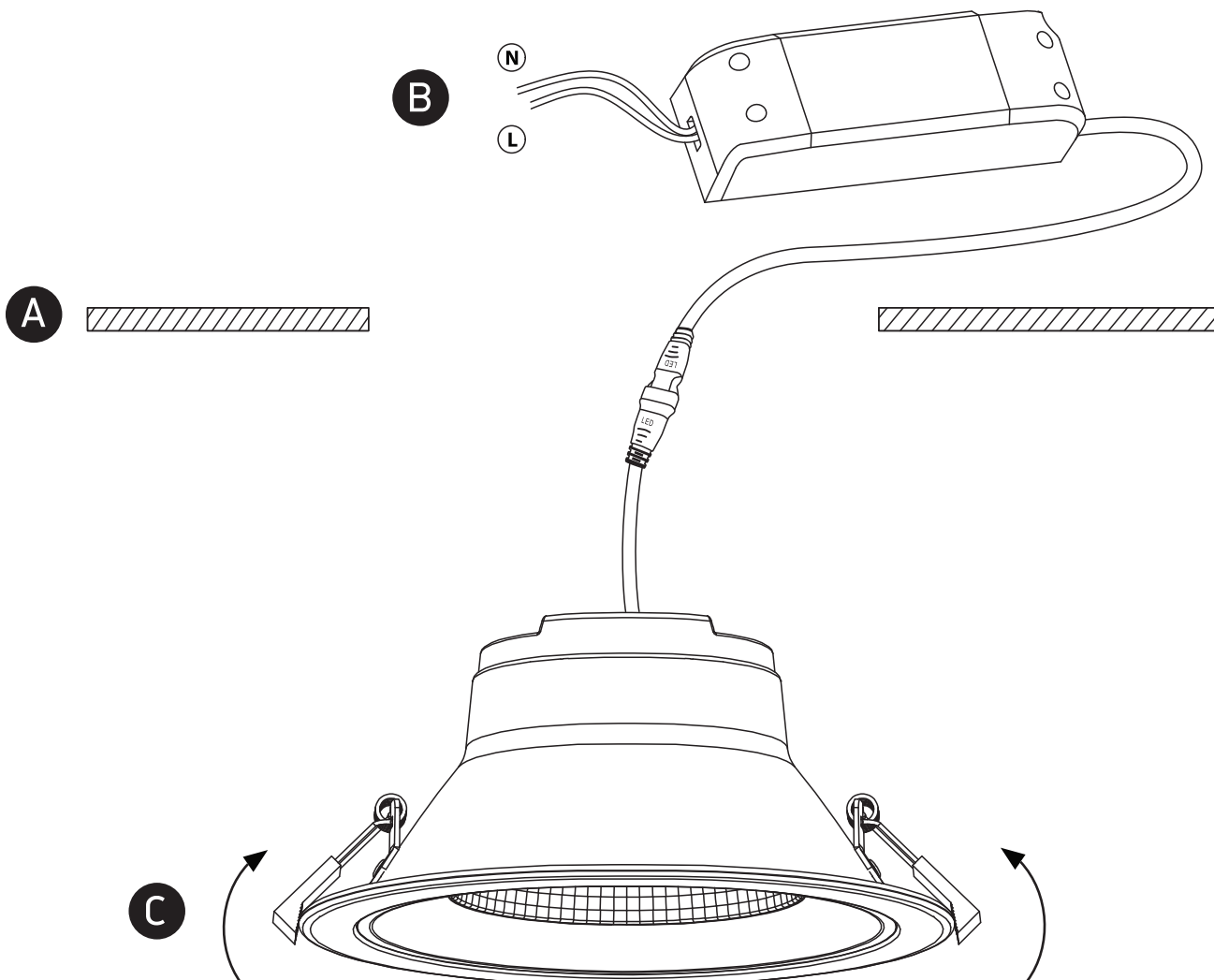

Warnings:

1. Make sure that the product is installed properly before connecting to electricity.
2. Do not cover the fitting.
3. Maintenance and installation should only be carried out by a professional electrician.