

INSTALLATION MANUAL

50012H

LED
BUILT IN



DARK
LIGHT

90
CRI



230V | SMD 3535 | 12W | IP20 | Aluminium
Complete with 700mA driver.

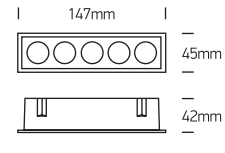
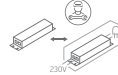

one
LIGHT

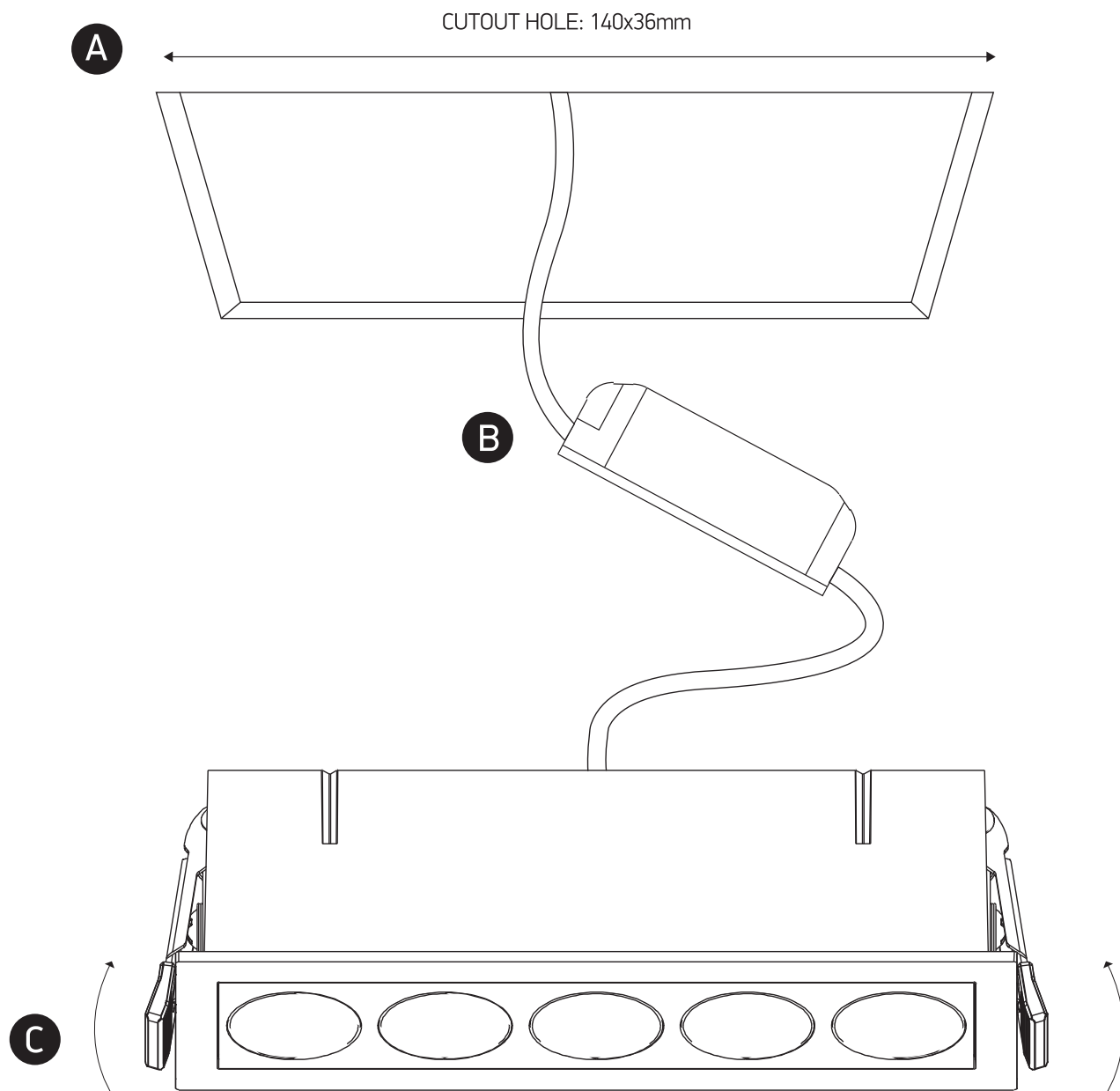

Warnings:

1. Make sure that the product is installed properly before connecting to electricity.
2. Do not cover the fitting.
3. Maintenance and installation should only be carried out by a professional electrician.