











INSTALLATION MANUAL

50012H

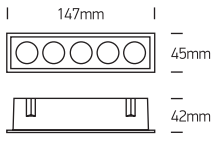
LED BUILT IN				DARK LIGHT	90 CRI	CE EAC UK CA				
230V SMD 3535 12W IP20 Aluminium Complete with 700mA driver.										

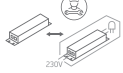

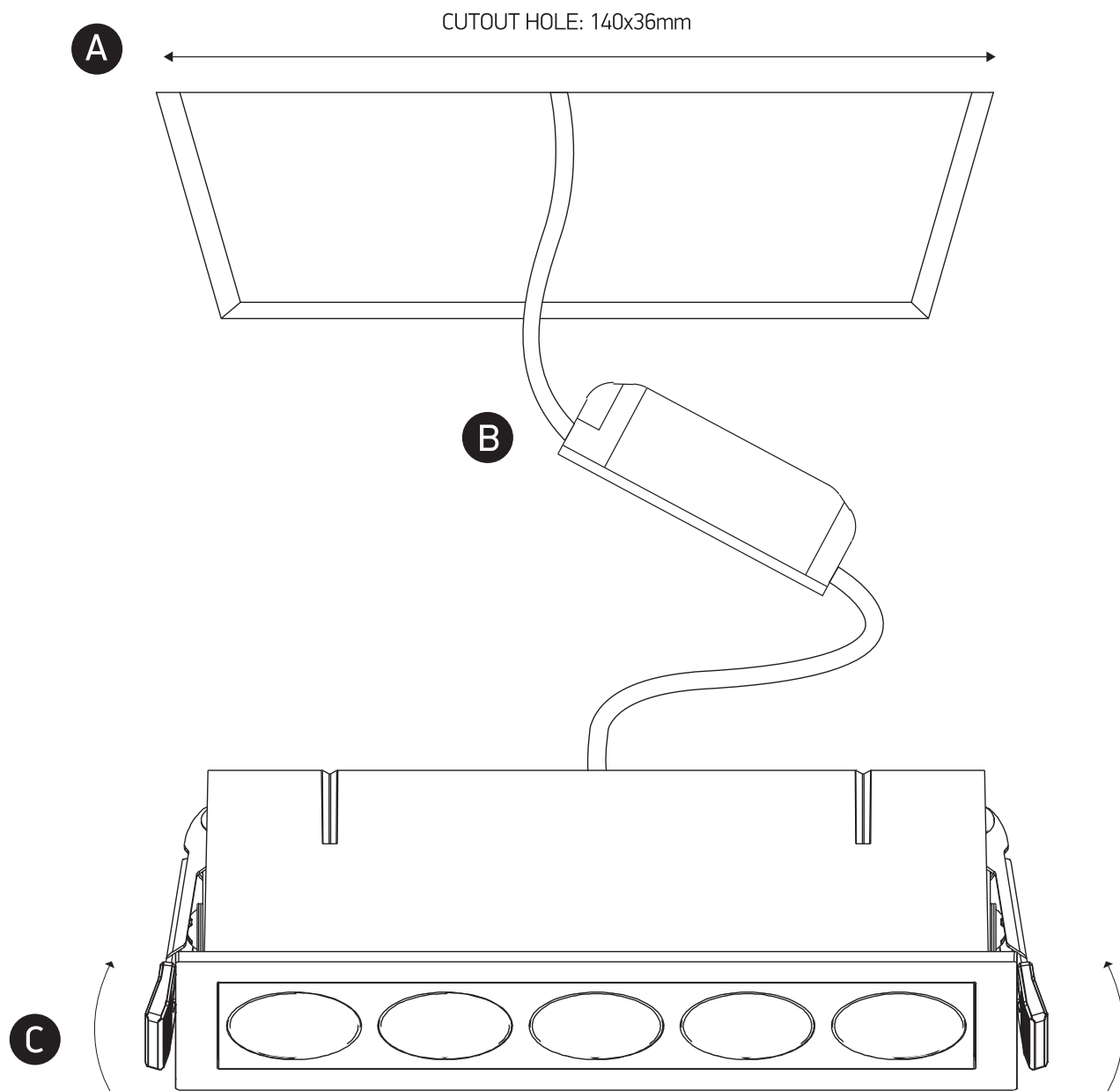
Warnings:

1. Make sure that the product is installed properly before connecting to electricity.
2. Do not cover the fitting.
3. Maintenance and installation should only be carried out by a professional electrician.