

INSTALLATION MANUAL

50302B

ecolight



90
CRI



700mA | LED | 3x2W | IP20 | Die cast

Use 89008A driver.

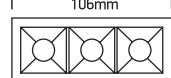

one
LIGHT

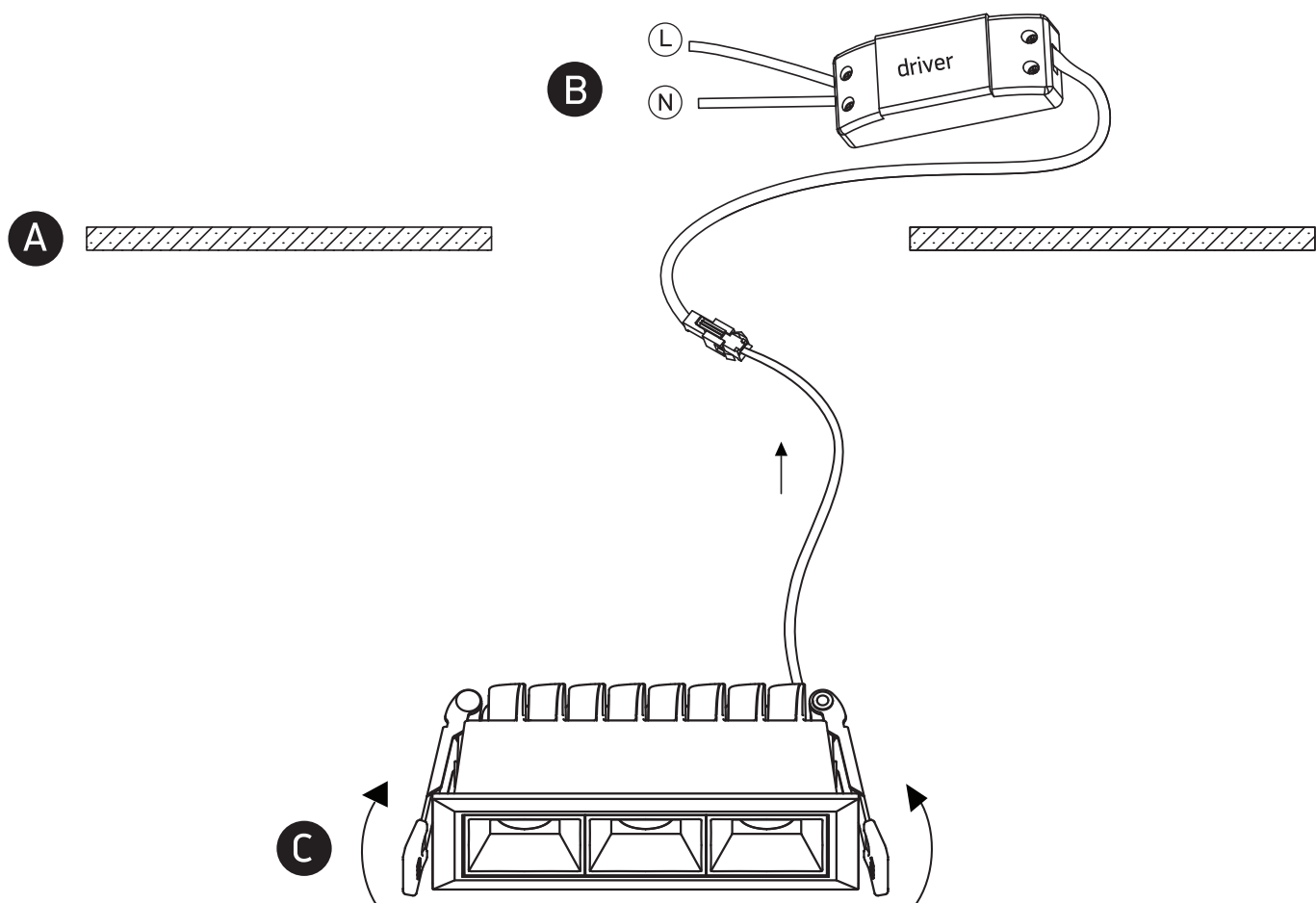

Warnings:

1. Make sure that the product is installed properly before connecting to electricity.
2. Do not cover the fitting.
3. Maintenance and installation should only be carried out by a professional electrician.