

INSTALLATION MANUAL

65505N

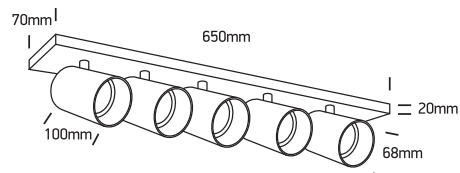

100-240V | MR16 | GU10 | 5x10W | IP20 | Aluminium | Adjustable

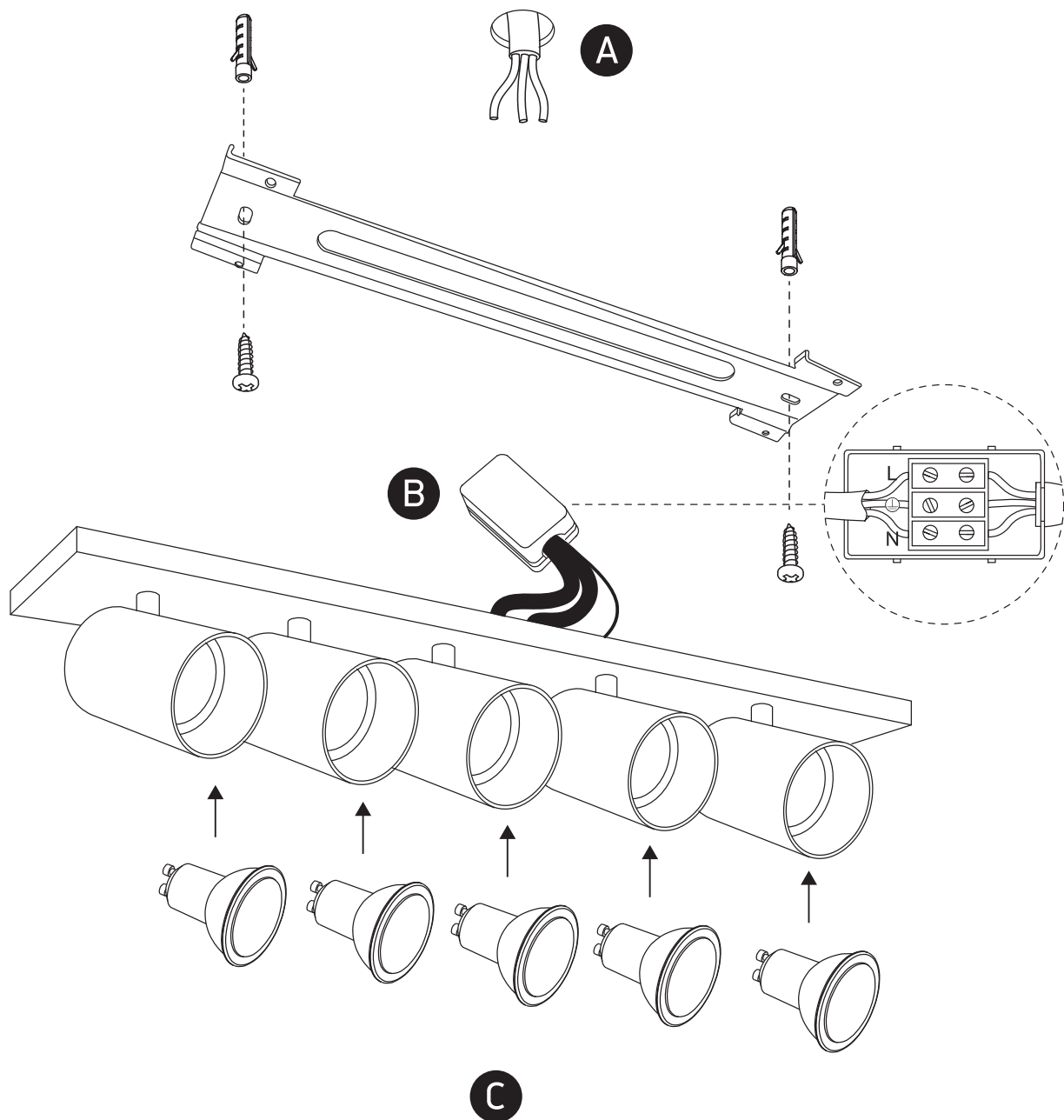

Warnings:

1. Make sure that the product is installed properly before connecting to electricity.
2. Do not cover the fitting.
3. Maintenance and installation should only be carried out by a professional electrician.