

# Specification

Prepared	Checked	Approved	Accepted	Confirmed	Approved

**UL** **CE** **RoHS** **COB** **LED Strip** **DC 24V** **IP 20** **5 Years**







**Model:**  RM0801MC-D

5000\*8 mm,1600 pcs COB LEDs, bare board series, constant voltage 24Vdc, flexible LED strip ( white 10W)

**Picture:**



**Features:**

-  High-density COB LEDs;
-  Linear lighting, without light spot, soft and uniform luminance ;
-  High CRI, high brightness and high efficiency;
-  High temperature resistance , long life;
-  Luminous surface width of  $4.5 \pm 0.3$ mm;
-  UL ,CE , RoHS compliant.

**Application:**

-  Suitable for indoor use as decorative lighting, such as corner decoration and contour lighting in KTV, shopping mall, cabinet and etc.

**Warranty:**

-  5 years or 22,000 hours, whichever comes first.

**Optical and Electrical Parameters:**

P/N	LED Color	CCT (K)		CRI	SDCM	Beam Angle(°)	Luminous Flux (lm/m)	Luminous Efficacy (lm/w)	Working voltage (VDC)	Working current(mA)		Power (w)	
		WL (nm)								1m[3 in]	5m[1 5in]	1m[3 in]	5m[1 5in]
RM0801MC-D	white	2700	$\geq 90$	3	140	800	80	24	415	1666	10	40	
RM0801MC-D	white	3000	$\geq 90$	3	140	800	80	24	415	1666	10	40	
RM0801MC-D	white	4000	$\geq 90$	3	140	930	93	24	415	1666	10	40	
RM0801MC-D	white	6500	$\geq 90$	3	140	1060	106	24	415	1666	10	40	

**Others:**

P/N	IP Grade	Operating Temperature		Storage Temp		Standard cascading length		Max. cascading length		COB Qty (pcs/m)	Weight	
		(°C)	(°F)	(°C)	(°F)	(m)	(inch)	(m)	(inch)		(g/m)	(lb/m)
RM0801MC-D	IP20	-25~+60	-13~+140	-25~+70	-13~+158	5	196.8	5	196.8	320	/	/

Notes:

- (1) Testing environment temperature: 25±2°C [77±3.6°F];
- (2) The actual data of each single product may differ from above typical data which are subject to change without prior notice;
- (3) Bending diameter ≥50mm, not suitable for channel letter.
- (4) The above "--" means the parameters are not required temporarily.

**Profile Drawings:**

Unit: mm[inch]

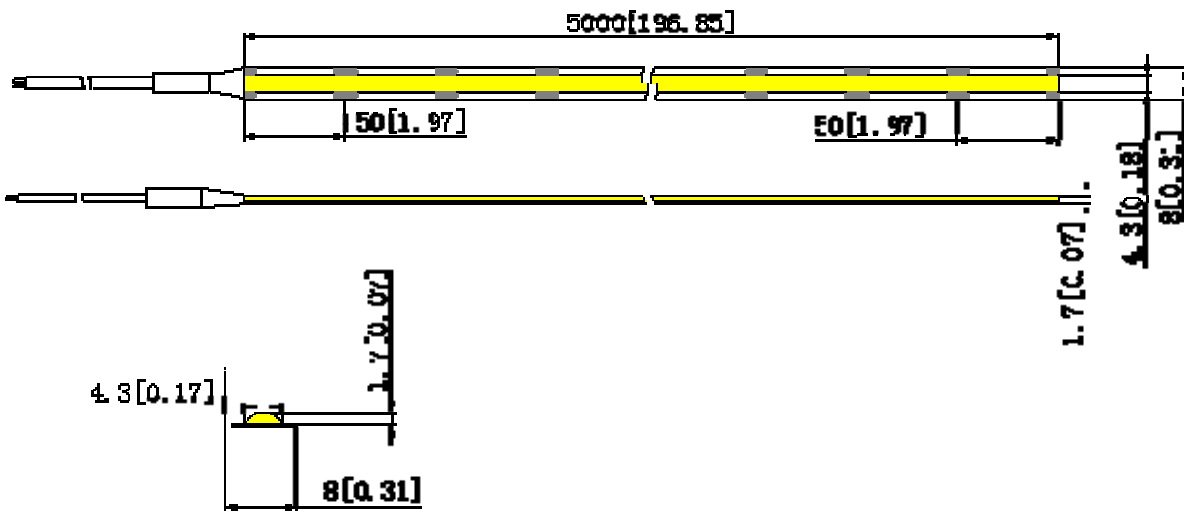

**Light Distribution/Iso-illuminance Diagram:**

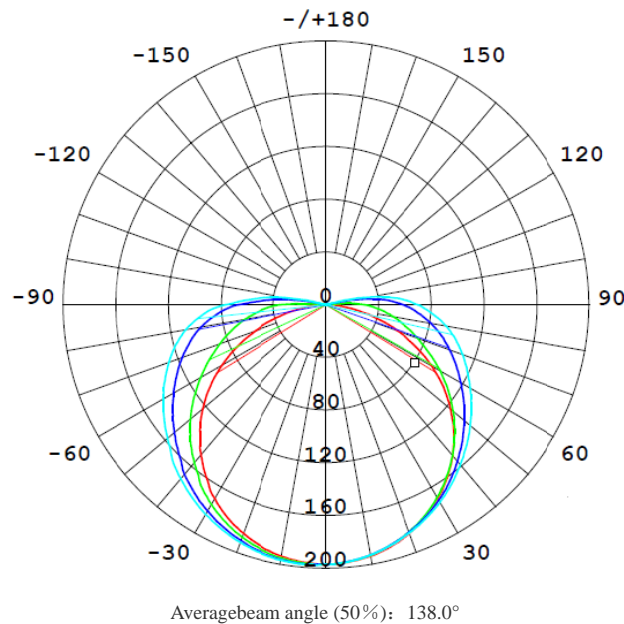

**Packaging Information:**

P/N	Qty (m/reel)	Qty (m/carton)	Total Qty (m)	Total weight		Outer carton size					
						length		width		height	
				(kg)	(lb)	(mm)	(inch)	(mm)	(inch)	(mm)	(inch)
RM0801MC-D	5	100	200	3.2	7.05	405	15.94	256	10.07	238	9.37

Notes: Above qty and weight of packing is only for the packing shown in the picture, which might be different from other packing modes, thus for actual qty and weight please refer to actual samples.

**Packaging Diagram:**

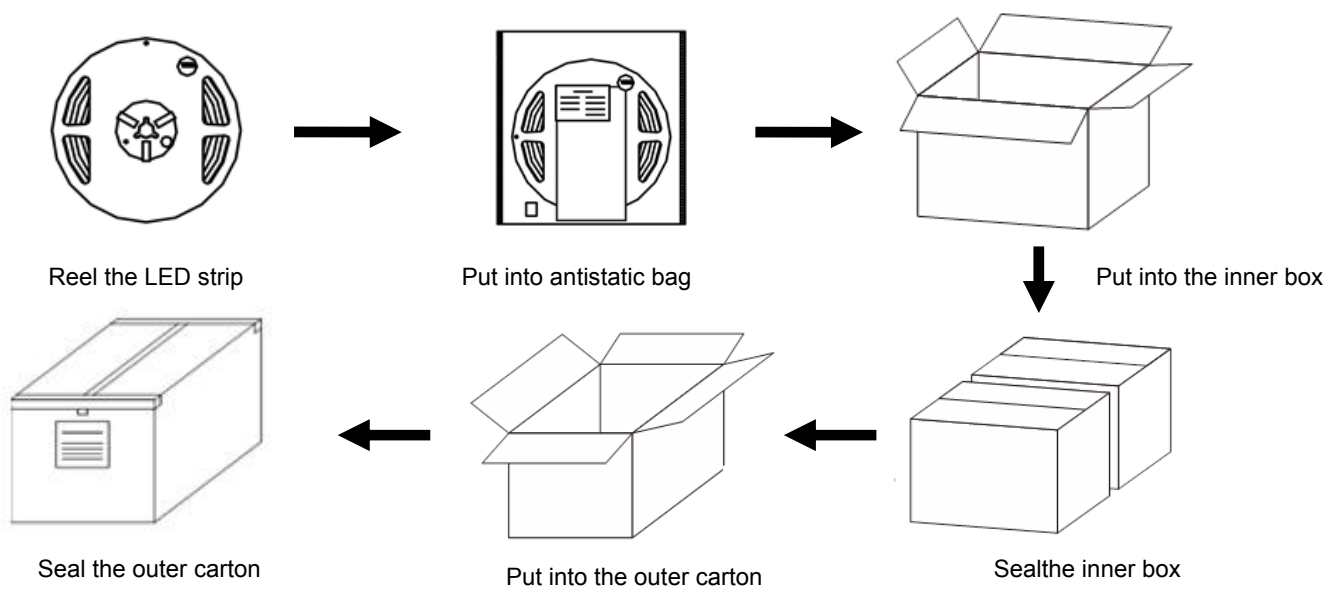

**Connection Instruction:**

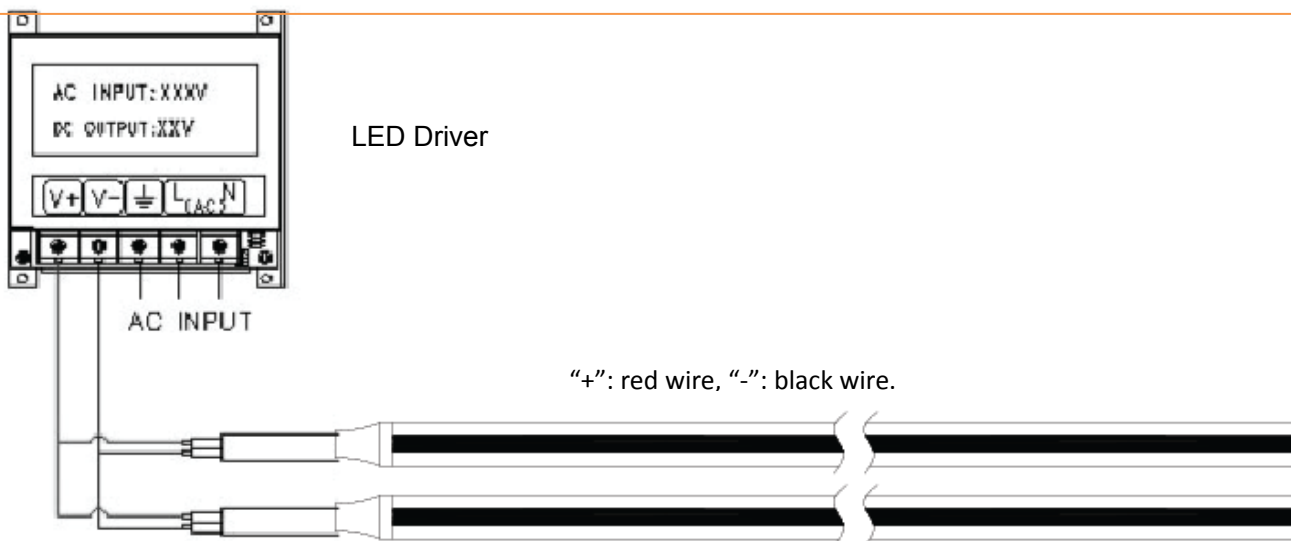

Notes: please make sure the “+” and “-” of the product’s input are correctly connected to those of the power supply output.

Parts & Tools:

ProductParts Self-provided Tools

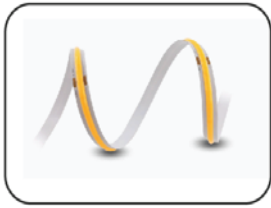

LED Strip



Electrical Drill & Drilling bit

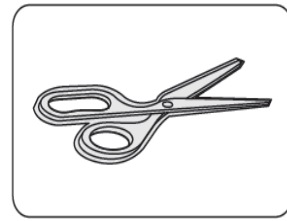

Scissors

Installation Steps& Cautions:

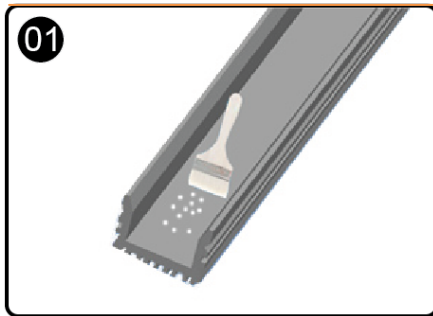

01 Clean the mounting surface

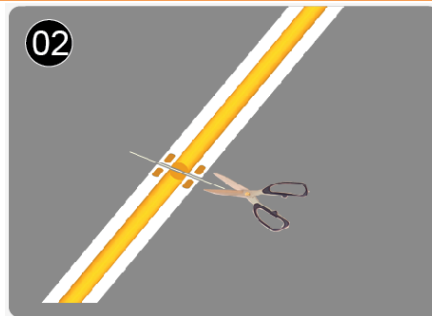

02 Calculate the needed length and cut off the extra length along cutting mark if necessary; if need to add wires, please weld them at the next location with printed mark.

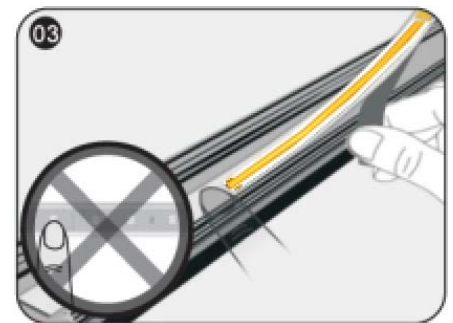

03 While sticking strips, peel off the release paper of the tape step by step. Don't peel off all release paper at one time to avoid getting your strip in a mess.  
△Notes: No pressing the LED bead!

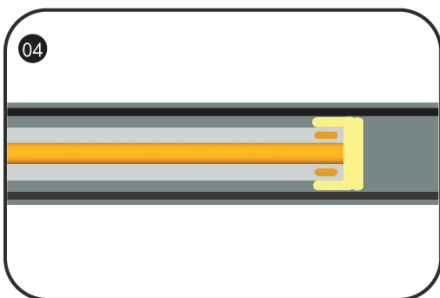

04 Stick Mylar tape to isolate the cutting position from the bottom of profile inner slot to avoid short-circuit;

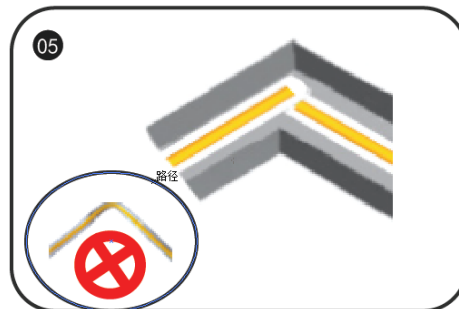

05 The installation at the corner is shown as the above figure.  
△ Notes: No bending it into right angle; No twisting it to stick on the mounting surface.

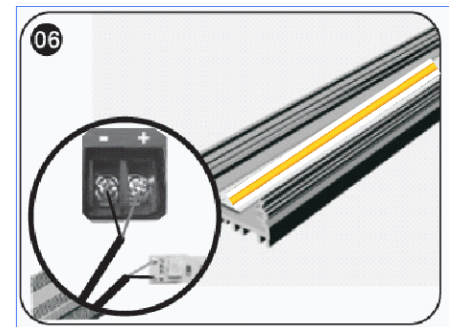

06 Connect strip wires to the output terminal of power supply, and dispose with waterproof, insulation, short-circuit and anti-corrosion protection at both the wire joints and the cut section of your strip (if any)

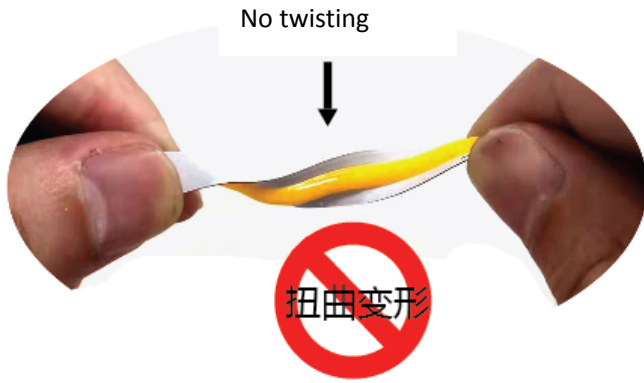

⊙ No twisting the strip

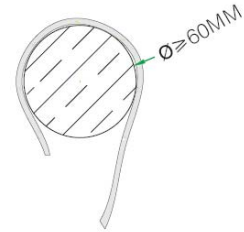
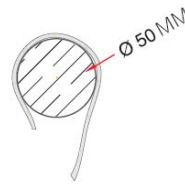

⊙ No winding an object with a diameter <5cm

**Troubleshooting:**

Malfunctions	Possible Causes	Solutions
All LEDs don't work	1. The power supply did not connect to power grid.	Power on
	2. No electricity due to short-circuit of external power supply.	Remove the malfunction caused by short-circuit, power on again.
	3. The wires of strips connect to power supply output reversely.	Check the connecting and ensure the wires are connected correctly.
Part of LEDs don't work	1. Part of power supplies do not have output.	Check the power supply system.
	2. Part of wires of strips have malfunction.	
	3. Particular modules connected reversely.	Correct connection
Brightness of LEDs is weak or uneven	1. Overloaded power supply;	Replace it with higher power supply
	2. The power loss of power circuit is huge or the power loss of each circuit existing big difference.	Ensure working voltage of strips is within $\pm 5\%$ of rated voltage. (1. Shorten the length of wires between the first strip and power supply or replaced with wires with bigger diameter; 2. Ensure the cascading qty of string is less than or equal to the allowed maximum cascading qty, and each strip cascading qty is well-balanced.)
	3. Exceed in qty of strips in series	Lessen the cascading qty for strip and ensure the qty for each electrical circuit is within the maximum cascading qty.
LEDs are blinking	1. Poor contacted in the joints.	Find out and tackle malfunction immediately.
	2. Failures in power supply.	Replace power supply.

**Declaration:**

---

- ⊙ If the external flexible cable of light box is damaged, please replace it by its manufacturer or its service agent or qualified person to avoid a hazard.
- ⊙ The specific installation and cautions please refer to the user manual.
- ⊙ The given data in this specification is based on our standard product. There may be existed slight difference compared with actual products.
- ⊙ All Illustrations in this specification are for reference only.
- ⊙ This product is subject to change or modify without prior notice.
- ⊙ RISHANG OPTOELECTRONICS CO., LTD reserves the right of final explanation for this specification.

<End>

**Rishang Optoelectronics Co., Ltd**(stock code: 002654)

Add: Block 2, Hongfa jiateli High-Tech. Park Tangtou Ave., Shiyan, Bao'an Shenzhen  
Guang Dong, 518108, China  
Tell: +86-755-36988588 E-mail: info@ledlamps.com.cn  
Website: www.ledlamps.com.cn

Website

Official Account

