

Specification

Prepared	Checked	Approved	Accepted	Confirmed	Approved



Model: Ⓞ RN0030TA/RN0060TA

5000*10, 150pcs, 2835 SMD LEDs, bare board series,
constant voltage 12Vdc, LED flex strip

5000*10, 300pcs, 2835 SMD LEDs, bare board series,
constant voltage 12Vdc, LED flex strip

Picture:



Features:

- Ⓞ 2835 SMD LEDs bring high luminous efficacy;
- Ⓞ Can be cut at the printed marks;
- Ⓞ Certification: CE, RoHS.

Applications:

- Ⓞ Suitable for cover and contour lighting etc, in KTV, hotel, shopping mall, home, cabinet and so on.

Bending radius \geq 5cm, not suitable for channel letter application.

Warranty:

- Ⓞ 3 years or 13,000 hours, whichever comes first.

Optical and Electrical Parameters:

P/N	LED Color	CCT (K) WL (nm)	CRI	SDCM	Beam Angle (°)	Luminous Flux (lm/m)	Luminous Efficacy (lm/w)	Working voltage (VDC)	Working current(mA)		Power(w)	
									1m[3 9.37i n]	5m[19 6.85in]	1m[3 9.37i n]	5m[1 96.85 in]
RN0030TA-A	Natural white	6000	\geq 75	--	115	468	78	12	500	2080	6	25
RN0030TA-A	Red	620-625	--	--	115	70	11.7	12	500	2333	6	28
RN0030TA-A	Blue	525-530	--	--	115	307	51.2	12	500	2083	6	25
RN0030TA-A	Green	465-470	--	--	115	74	12.3	12	500	2083	6	25
RN0030TA-A	Yellow	585-590	--	--	115	39	6.5	12	500	2333	6	28
RN0060TA-A	Natural white	6000	\geq 75	--	115	955.5	79.6	12	1000	3583	12	43
RN0060TA-A	Red	620-625	--	--	115	128	10.7	12	1000	3750	12	45
RN0060TA-A	Blue	525-530	--	--	115	623	51.9	12	1000	3583	12	43
RN0060TA-A	Green	465-470	--	--	115	148	12.3	12	1000	3583	12	43
RN0060TA-A	Yellow	585-590	--	--	115	66	5.5	12	1000	3750	12	45

Others:

P/N	IP Grade	Operating Temp		Storage Temp		Standard length		Max. cascading length		LED Qty (pcs/m)	Weight	
		(°C)	(°F)	(°C)	(°F)	(m)	(inch)	(m)	(inch)		(g/m)	(lb/m)
RN0030TA-A	IP20	-25~ +60	-13~ +140	-25~ +70	-13~ +158	5	196.85	5	196.85	30	/	/
RN0060TA-A	IP20	-25~ +60	-13~ +140	-25~ +70	-13~ +158	5	196.85	5	196.85	60	/	/

- Notes:
- (1) Testing environment temperature: 25±2°C [77±3.6°F];
 - (2) The above data each single product could differ from the typical values. The data subject to change without prior notice;
 - (3) The above “-” represents that SDCM parameters do not need to be filled in.

Profile Drawings:

Unit: mm[inch]

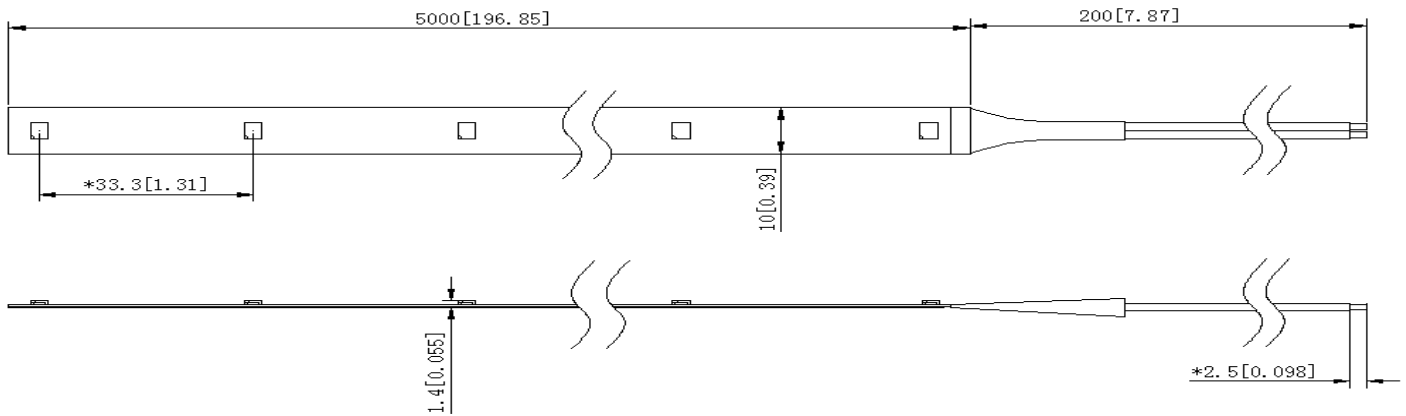

Packaging Information:

P/N	Qty (m/reel)	Qty (m/carton)	Total Qty (m)	Total weight		Outer carton size					
				(Kg)	(lb)	length		width		height	
						(mm)	(inch)	(mm)	(inch)	(mm)	(inch)
RN0030TA	5	100	200	4.04	8.90	390	15.35	250	9.84	226	8.89
RN0060TA	5	100	200	4.24	9.34	390	15.35	250	9.84	226	8.89

Notes: the actual packed and weight may subject to without prior notice.

Packaging Diagram:

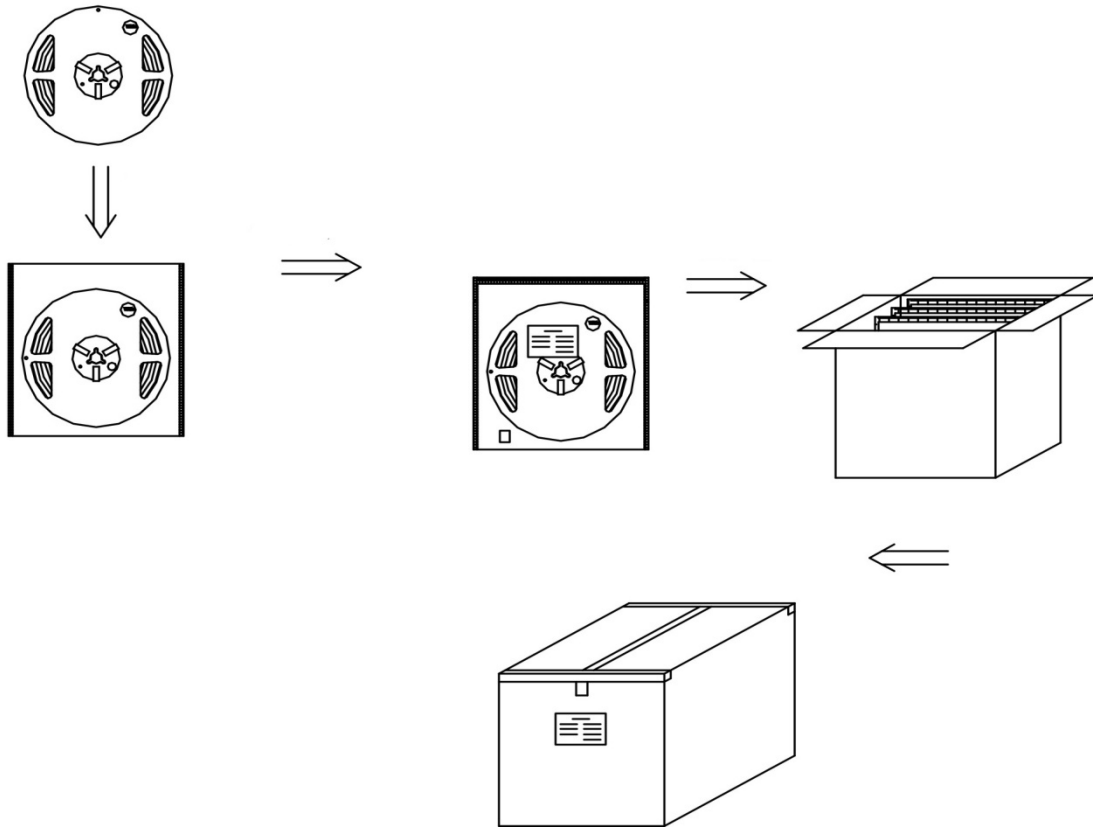

Connection Instruction:

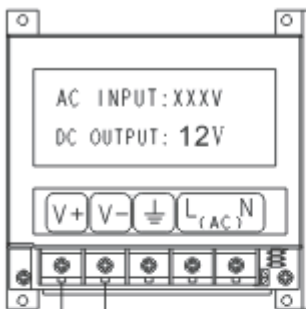

Notes: please make sure the "+" and "-" of the product's input are correctly connected to those of the power supply output.

Positive: red wire Negative: black wire



Installation Steps & Cautions:



○ Peel off the release paper



○ Stick them to the mounting surface

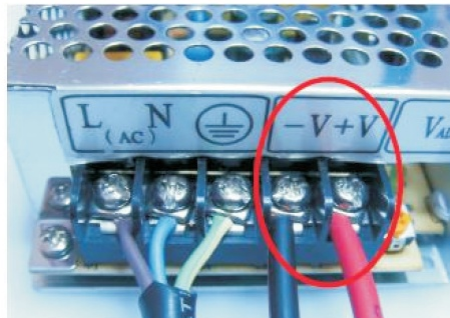

○ Mounted the snap spring.

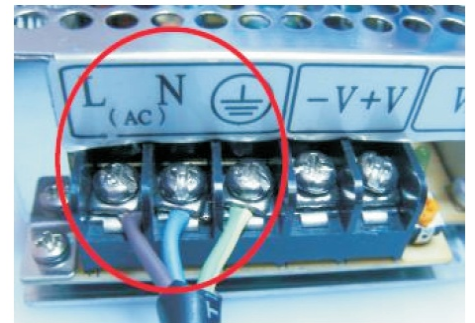

○ Installation is complete

○ Connect the wires of power supply

○ Connect the wires of power adapter

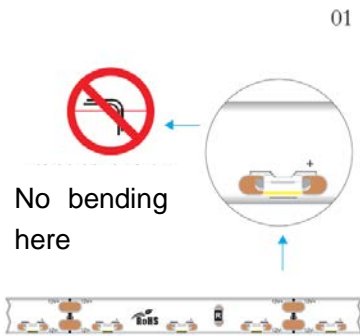

○ No bend the strip at the position of LED

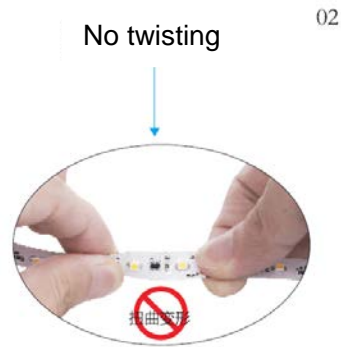

○ No twisting the strip

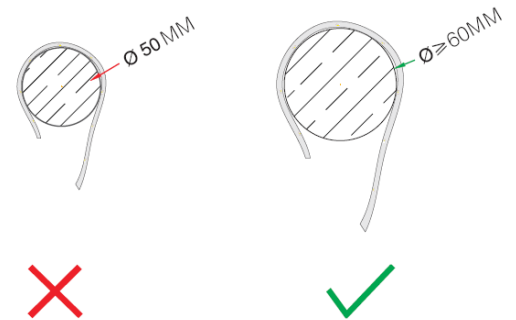

○ No winding an object with a diameter <5cm.

Optional Parts:

Category	Part Name	Figure	Specifications/Description	Article Number	Color	IP Grade	Notes
Cable	SM female terminal				Reddish black	IP33	

Troubleshooting:

Malfunctions	Possible Causes	Solutions
All LEDs don't work	1. The power supply did not connect to power grid.	Power on
	2. No electricity due to short-circuit of external power supply.	Remove the malfunction caused by short-circuit, power on again.
	3. The wires of strip light connect to power supply output reversely.	Check the connecting and ensure the wires are connected correctly.
Part of LEDs don't work	1. Part of power supplies do not have output.	Check the power supply system.
	2. Part of wires of strip light have malfunction.	
	3. Particular strip light connected reversely.	Correct connection
Brightness of LEDs is weak or uneven	1. Overloaded power supply;	Replace it with higher power supply
	2. The power loss of power circuit is huge or the power loss of each circuit existing big difference.	Ensure working voltage of strips is within $\pm 5\%V$ of rated voltage. 1. Shorten the length of wires between the first strip and power supply or replaced with wires with bigger diameter; 2. Ensure the cascading qty of string is less than or equal to the allowed maximum cascading qty, and each strip cascading qty is well-balanced.
	3. Exceed in qty of strip light in series	Lessen the cascading qty for strip and ensure the qty for each electrical circuit is within the maximum cascading qty.
LEDs are blinking	1. Poor contacted in the joints.	Find out and tackle malfunction immediately.
	2. Failures in power supply.	Replace power supply.

Declaration:

- ⊙ If the external flexible cable of light box is damaged, please replace it by its manufacturer or its service agent or qualified person to avoid a hazard.
- ⊙ The specific installation and cautions please refer to the user manual.
- ⊙ The given data in this specification is based on our standard product. There may be existed slight difference compared with actual products.
- ⊙ All Illustrations in this specification are for reference only.
- ⊙ This product is subject to change or modify without prior notice.
- ⊙ RISHANG OPTOELECTRONICS CO., LTD reserves the right of final explanation for this specification.

<End>

Rishang Optoelectronics Co., Ltd (stock code: 002654)

Add: Block 2, Hongfa jiateli High-Tech. Park Tangtou Ave., Shiyan, Bao'an Shenzhen
Guang Dong, 518108, China

Tell: +86-755-33258896 E-mail: info@ledlamps.com.cn

Website: www.ledlamps.com.cn



Website



Wechat Accounts

