

Specification

Prepared	Checked	Approved	Accepted	Confirmed	Approved

UL	CE	RoHS	2835 SMD	60/72 LEDS/M	LED Strip	DC 12V	IP 20	3 Years
-----------	-----------	------	--------------------	-----------------	----------------------------	------------------	-----------------	-------------------

Model: RN0W60TA-B-2/ RN0W72TA-B-1

5000*8, 300pcs 2835 SMD LEDs, bare board series, constant voltage, DC12V, LED flex strip (3D)

5000*6mm, 360pcs 2835 SMD LEDs, bare board series, constant voltage, DC12V, LED flex strip (3D)

Picture:



Features:

- ⊙ 2835 SMD LED with long lifespan, low attenuation and high efficiency;
- ⊙ V type structure, can be bent and shaped arbitrarily;
- ⊙ Adopt 3M back adhesive;
- ⊙ White FPC board, ensuring excellent effect;
- ⊙ CE, RoHS, UL compliant

Applications:

- ⊙ Suitable for 3-6cm depth signage lighting, small channel letter, abnormal shaped channel letter.

Warranty:

- ⊙ 3 years or 13,000 hours, whichever comes first

Optical and Electrical Parameters:

P/N	LED Color	CCT (K) WL (nm)	CRI	SDCM	Beam Angle (°)	lm/m	lm/W	V DC	mA		W	
									1m	2m	1m	2m
RN0W60TA-B-2	White	6500	≥80	--	≥115	650	100	12	540	1000	6.5	12
RN0W60TA-B-2	White	10000	≥80	--	≥115	615	95	12	540	1000	6.5	12
RN0W72TA-B-1	White	6500	≥80	--	≥115	720	100	12	600	1125	7.2	13.5
RN0W72TA-B-1	White	10000	≥80	--	≥115	680	95	12	600	1125	7.2	13.5

Others:

P/N	IP Grade	Operating Temp (°C)	Storage Temp (°C)	Standard length (m)	Max. cascading length (m)	LED Qty (pcs/m)	Weight (g/m)
RN0W60TA-B-2	IP20	-25~+60	-25~+70	5	2	60	14
RN0W72TA-B-1	IP20	-25~+60	-25~+70	5	2	72	15

Notes:

- ① Testing environment temperature: 25±2°C [77±3.6°F];
- ② The actual data of each single product may differ from above typical data which are subject to change without prior notice;
- ③ The above “—” means the parameters are not required temporarily;
- ④ For the color temperature that isn't included in the specification, please refer to the actual data. The parameters of power, luminous flux and efficacy may have ±10% error.
- ⑤ Taking electricity every two meters

Profile Drawings:

Unit: mm[inch]

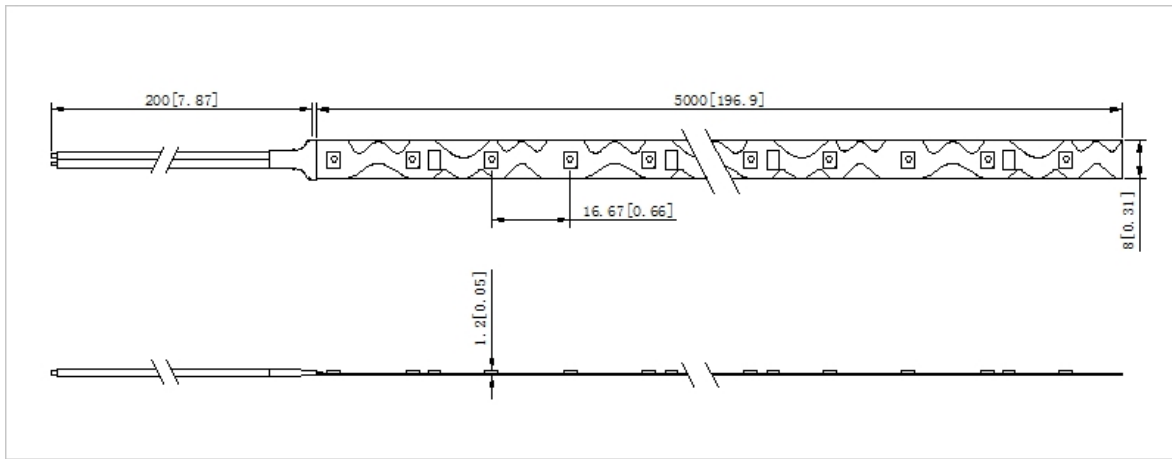

RN0W60TA-B-2

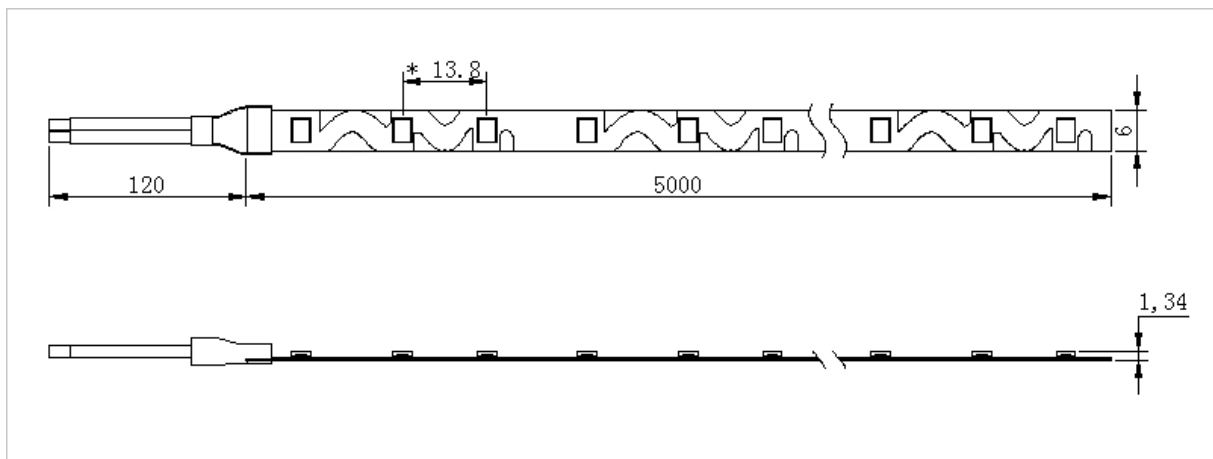

RN0W72TA-B-1

Light Distribution Curve/Isolux Diagram:

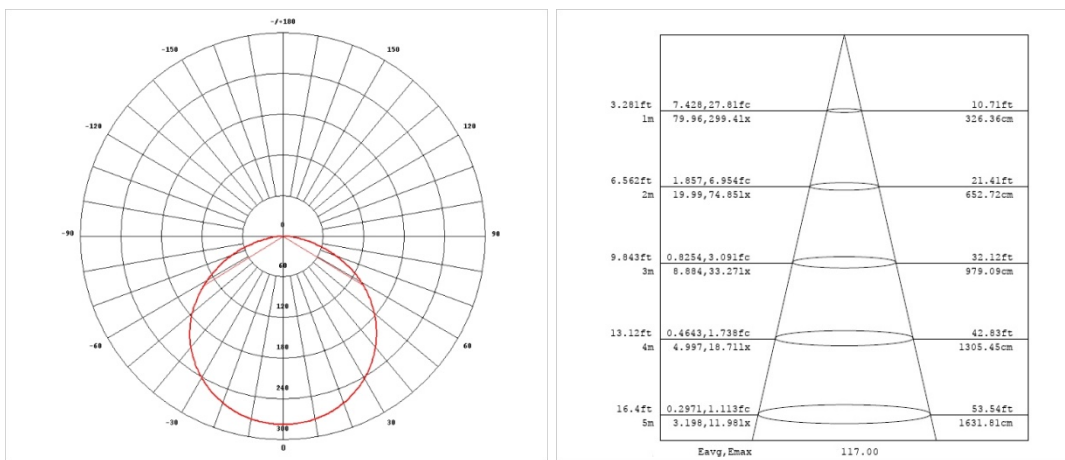

RN0W60TA-B-2

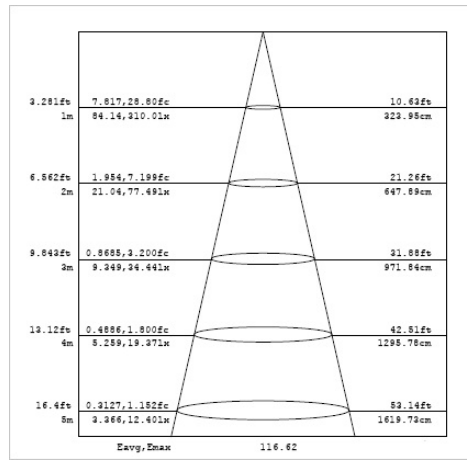
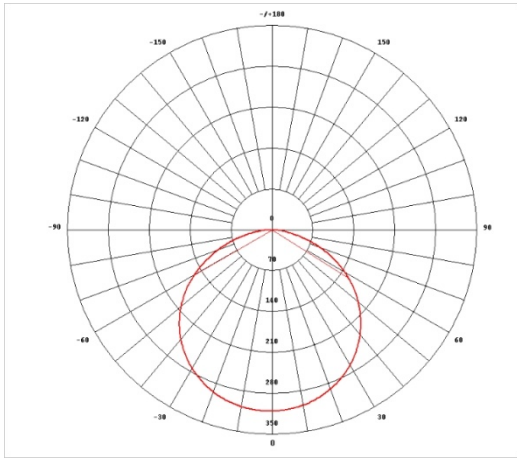

RNOW72TA-B-1

Packaging Information:

P/N	Qty (m/reel)	Qty (m/carton)	Total Qty (m)	Total weight (Kg)	Outer carton size (mm)		
					length	width	height
RNOW60TA-B-2	10	850	850	13.6	458	256	268
RNOW72TA-B-1	10	1000	1000	13	458	256	268

Packaging Diagram:

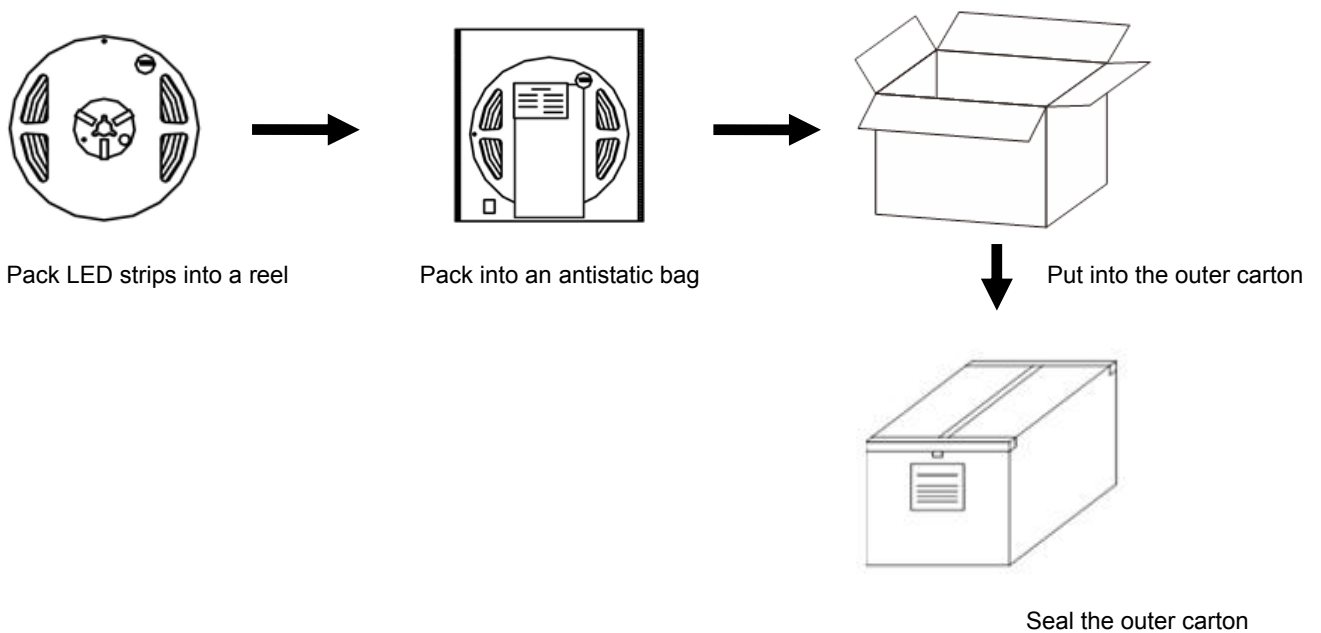

Connection Instruction:

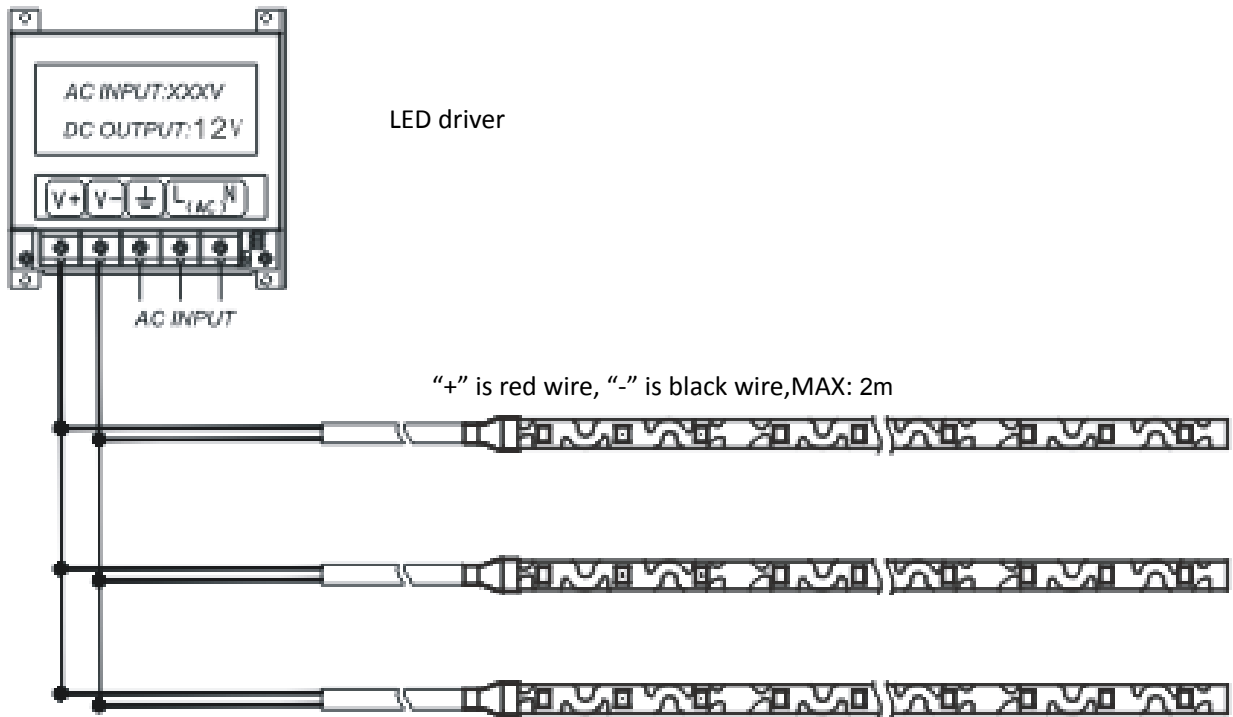

(Note: Please connect the ‘+’ and ‘-’ of wires to those of power supply output correctly.)

Parts & Tools:

Product Spare Parts

Self-provided Tools

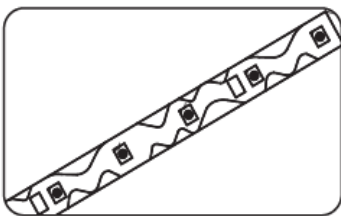

LED Strip



Soldering tool

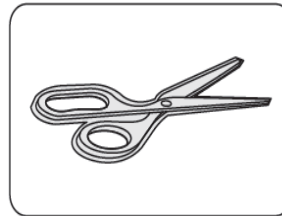

Scissors



Wire

Installation Steps & Cautions:

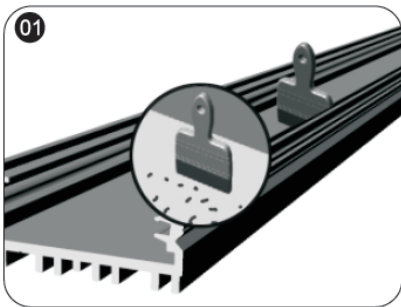

01 Make sure the mounting surface is clean before installation;

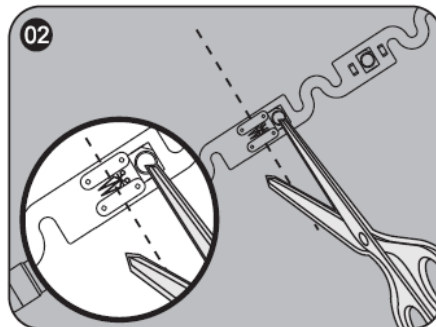

02 Calculate the needed length and cut off the extra length along cutting mark if necessary.

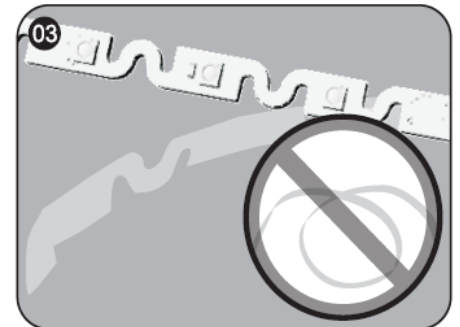

03 Determine the installing position, peel off the release paper of the tape while installing, not to mess the strip up.

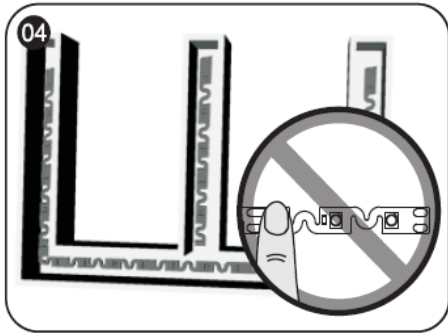

- Stick the strip to the installing surface. No pressing the bead.

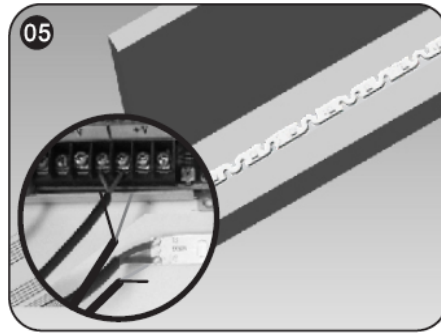

- Connect strip wires to the output terminal of power supply, and dispose with waterproof, insulation, short-circuit and anti-corrosion protection at both the wire joints and the cut section of your strip (if any)

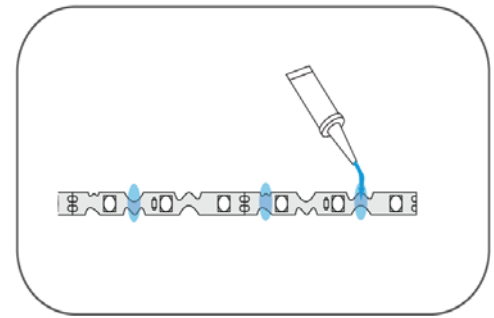

After installing the LED strip, LED strip surface is glued once again to reinforce the LED strip on the board at least every 10cm so as to prevent the LED strip from detaching. Note that glue cannot be coated on the LEDs.

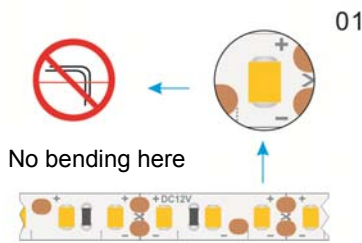

- No bending the strip at the position of LED

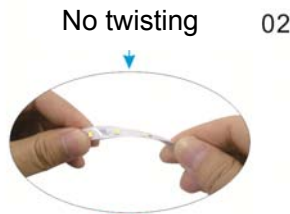

- No twisting the strip

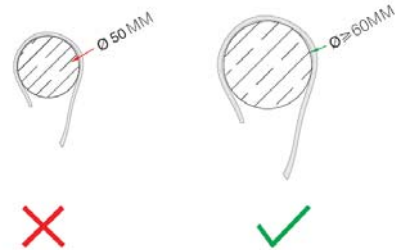

- No winding an object with a diameter <5cm

Troubleshooting:

Malfunctions	Possible Causes	Solutions
All LEDs don't work	1. The power supply did not connect to power grid.	Power on
	2. No electricity due to short-circuit of external power supply.	Remove the malfunction caused by short-circuit, power on again.
	3. The wires of strips connect to power supply output reversely.	Check the connecting and ensure the wires are connected correctly.
Part of LEDs don't work	1. Part of power supplies do not have output.	Check the power supply system.
	2. Part of wires of strips have malfunction.	
	3. Particular modules connected reversely.	Correct connection
Brightness of LEDs is weak or uneven	1. Overloaded power supply;	Replace it with higher power supply
	2. The power loss of power circuit is huge or the power loss of each circuit existing big difference.	Ensure working voltage of strips is within $\pm 5\%V$ of rated voltage. (1. Shorten the length of wires between the first strip and power supply or replaced with wires with bigger diameter; 2. Ensure the cascading qty of string is less than or equal to the allowed

		maximum cascading qty, and each strip cascading qty is well-balanced.)
	3. Exceed in qty of strips in series	Lessen the cascading qty for strip and ensure the qty for each electrical circuit is within the maximum cascading qty.
LEDs are blinking	1. Poor contacted in the joints.	Find out and tackle malfunction immediately.
	2. Failures in power supply.	Replace power supply.

Declaration:

- ⊙ If the external flexible cable of light box is damaged, please replace it by its manufacturer or its service agent or qualified person to avoid a hazard.
- ⊙ The specific installation and cautions please refer to the user manual.
- ⊙ The given data in this specification is based on our standard product. There may be existed slight difference compared with actual products.
- ⊙ All Illustrations in this specification are for reference only.
- ⊙ This product is subject to change or modify without prior notice.
- ⊙ RISHANG OPTOELECTRONICS CO., LTD reserves the right of final explanation for this specification.

<End>

Rishang Optoelectronics Co., Ltd (stock code: 002654)

Add: Block 2, Hongfa jiateli High-Tech. Park Tangtou Ave., Shiyan, Bao'an Shenzhen
 Guang Dong, 518108, China
 Tell: +86-755-36988588 E-mail: info@ledlamps.com.cn
 Website: www.ledlamps.com.cn

Website



Official Account

